

TROXNETCOM AS-i

Power supply units



AS-i system voltage for master, sensors, actuators, and modules

AS-Interface power supply units for power supply and unimpaired data transmission

- High efficiency of 88 % or 90.9 %
- Low ripple, < 50 mV or < 100 mV
- Input and output with overvoltage protection
- With short circuit, idle and overload protection
- Increased operational reliability due to the bridging of voltage drops
- Very high efficiency, hence very low heat build-up
- LED for secondary voltage
- Power supply units meet the requirements of VDE 0106 for AS-i networks



Description



TNC-A1256

Application

- AS-i power supply unit TNC-1256 (2.8 A) with data decoupling
- Voltage supply for sensors, actuators and modules
- For systems where the power supply is not provided by AS-i
- Very high efficiency of 88 %
- Low ripple, < 50 mV
- High reliability

Technical data

Description	TNC-A1256
Output current	2.8 A
Nominal voltage, primary	115/230 V AC (switching is possible)
Input voltage range	100 – 120/200 – 240 V AC; ± 10 %; automatic switching between ranges
Nominal frequency	50/60 Hz
Efficiency	86.9 % (120 V AC; 60 Hz)/88 % (230 V AC; 50 Hz)
Casing	Sheet steel
IP protection level	IP 20
Connection	Screw terminals
Temperature range	-25 to 70 °C
Derating	0 W/K (60 – 70 °C)
Output voltage	30.5 DC
Power ON delay time	≤ 900 ms
Residual ripple	< 50 mV
Mains buffering time	98 ms (120 V AC; 60 Hz)/96 ms (230 V AC; 50 Hz)
With short circuit protection / overload protection	Yes
EMC	EN 61000-6-1; EN 61000-6-2; EN 61000-6-4
MTBF	801000 h
AS-i certificate	98701
Status LED	Green (display of AS-i voltage)
Fixing	On mounting rail

Wiring

**Connecting cable core identification
TNC-A1256**

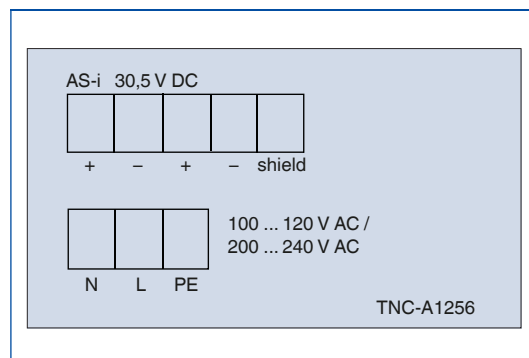

Dimensions

Power supply unit TNC-A1256

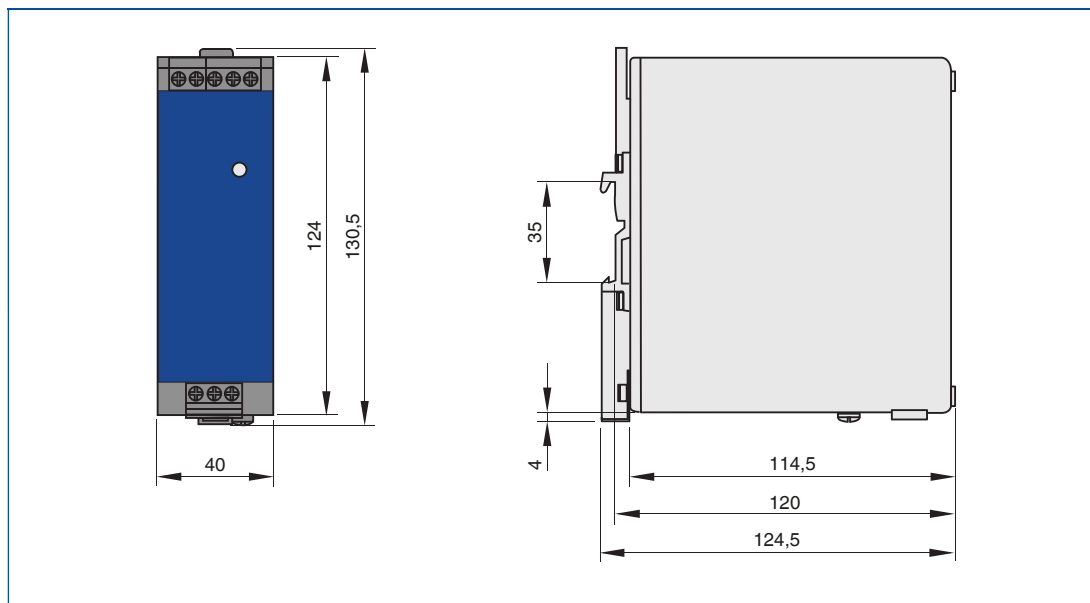

Specification text

Standard description (characteristics)

AS-i power supply units, 115/230 V AC, with data decoupling, ensure power supply for master, sensors, actuators and modules.

- Nominal voltage: 115/230 AC V
- Nominal frequency: 50/60 Hz
- Efficiency: 88 %
- Connection: Screw terminals
- Casing materials: Galvanised sheet steel
- Ambient temperature: -25 to 70 C°
- IP protection level: IP 20
- Function LED: Green (display of AS-i voltage)
- Make: TROX GmbH or equivalent
- Type: TNC-A1256

Description



TNC-A1258

Application

- TROX AS-i power supply unit TNC-1258 (8 A) with data decoupling
- Voltage supply for sensors, actuators and modules
- For systems where the power supply is not provided by AS-i
- Very high efficiency of 90.9 %
- Low ripple, < 100 mV
- High reliability

Technical data

Description	TNC-A1258
Output current	8 A
Nominal voltage, primary	115/230 V AC (switching is possible)
Input voltage range	100 – 120/200 – 240 V AC; ± 10 %; automatic switching between ranges
Nominal frequency	50/60 Hz
Efficiency	89.4 % (120 V AC; 60 Hz)/90.9 % (230 V AC; 50 Hz)
Casing	Sheet steel
IP protection level	IP 20
Connection	Screw terminals
Temperature range	-25 to 70 °C
Derating	6 W/K (60 – 70 °C)
Output voltage	30.5 DC
Power ON delay time	≤ 800 ms
Residual ripple	< 100 mV
Mains buffering time	44 ms (120 V AC; 60 Hz)/42 ms (230 V AC; 50 Hz)
With short circuit protection / overload protection	Yes
EMC	EN 61000-6-1; EN 61000-6-2; EN 61000-6-4
MTBF	771000 h
AS-i certificate	98501
Status LED	Green (display of AS-i voltage)
Fixing	On mounting rail

Wiring

**Connecting cable core identification
TNC-A1258**

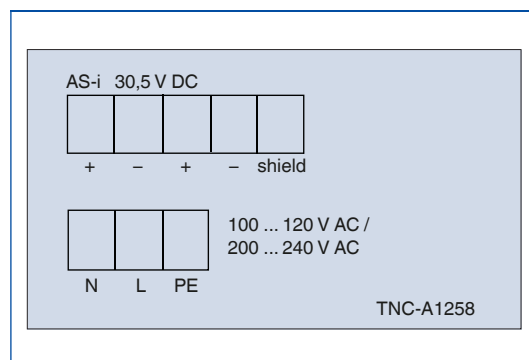

Dimensions

Power supply unit TNC-A1258

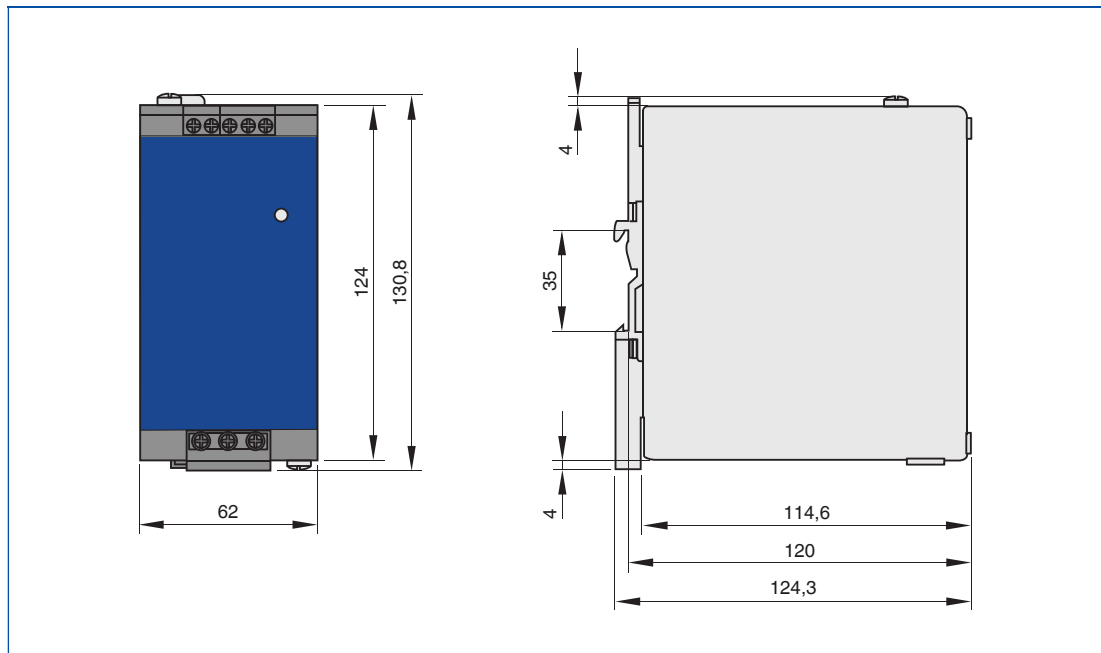

Specification text

Standard description (characteristics)

AS-i power supply units, 115/230 V AC, with data decoupling, ensure power supply for master, sensors, actuators and modules.

- Nominal voltage: 115/230 AC V
- Nominal frequency: 50/60 Hz
- Efficiency: 90.9 %
- Connection: Screw terminals
- Casing materials: Galvanised sheet steel
- Ambient temperature: -25 to 70 C°
- IP protection level: IP 20
- Function LED: Green (display of AS-i voltage)
- Make: TROX GmbH or equivalent
- Type: TNC-A1258

TROXNETCOM

Basic information and nomenclature



- Communication systems for fire protection systems
- Colour codes according to IEC 60757
- AS-Interface
- LON

Description

Information and communication are becoming more and more important in today's world. People not only want more information, they also want more detailed information. This development is also visible in building automation, and there is no end in sight. A building becomes 'transparent' through distributed intelligence and new decentralised communication systems.

These new technologies allow us to develop bespoke system solutions for various building services and to integrate them with building management systems. In this way, the best solutions for the different building services can be combined to create the best possible overall solution. Decentralised communication systems offer you the most advanced technology for your application requirements.

Communication systems for fire protection systems

The functional safety of programmable electronic systems is becoming more and more important in fire protection and is implemented with regard to protection goals and risks. According to IEC 61508, the requirements for these systems are based on a risk analysis. Components are given an SIL rating (safety integrity level) and must meet the corresponding requirements to ensure safety even in case of a malfunction.

General advantages of decentralised bus systems

It is no longer necessary to wire every single actuator and every single controller. Modern bus systems only need one bus cable, and in some cases a supply cable, to connect all components. This saves not only installation time but also cables, connectors, terminal blocks, and control cabinet space. It also drastically reduces the fire load and the installation costs. All signals from all components on a bus can be retrieved and recorded by the central unit. Inspection is simplified, and measurement and control can be optimised.

Communications system

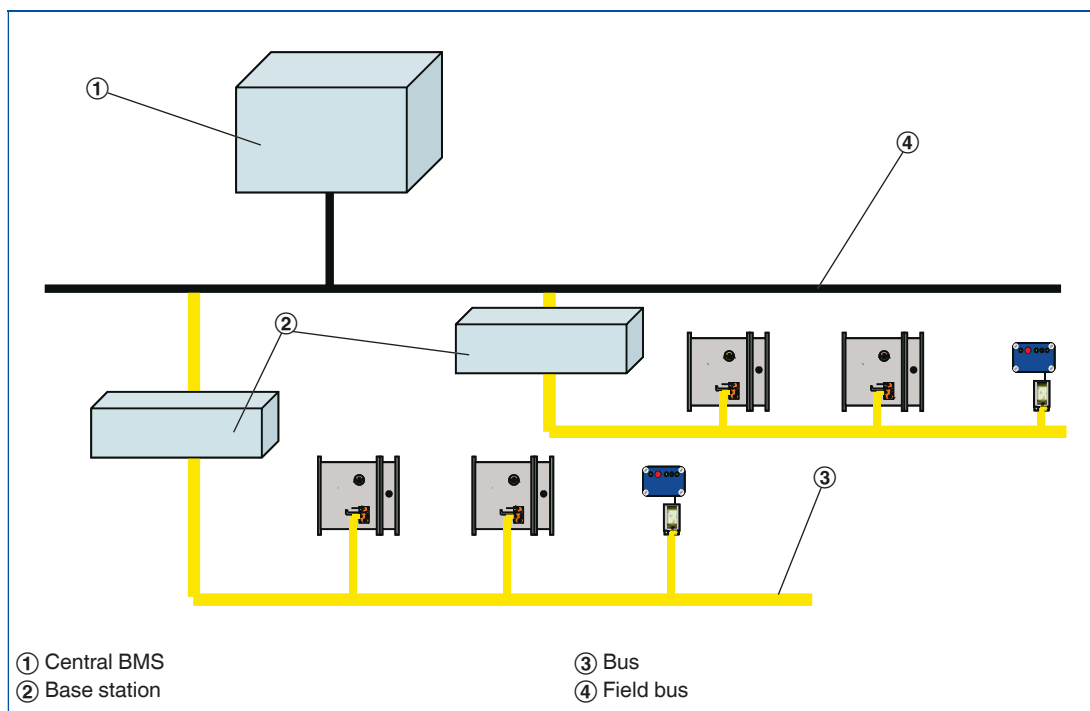

Wiring

Colour codes according to IEC 60757

Code	Colour
BK	black
BN	brown
RD	red
OG	orange
YE	yellow
GN	green
BU	blue

Colour codes according to IEC 60757

Code	Colour
VT	violet
GY	grey
WH	white
PK	pink
TQ	turquoise
GNYE	green-yellow

Description

The AS interface is a world-standard bus system according to EN 50295 and IEC 62026-2. It enables the integration of different components (modules) in a network regardless of the manufacturer and the design. The modules control actuators and/or receive signals from sensors. TROX provides a system for controlling fire dampers, smoke protection dampers and smoke control dampers based on the AS-i standard. TROX modules are characterised by a wide spectrum of functions yet simple cabling.

Special characteristics

- Data exchange and power supply with just one cable
- Central control of actuators and monitoring of damper blade positions and duct smoke detectors
- Simple commissioning using standardised software
- Automatic function test including data logging

The system

Communications system

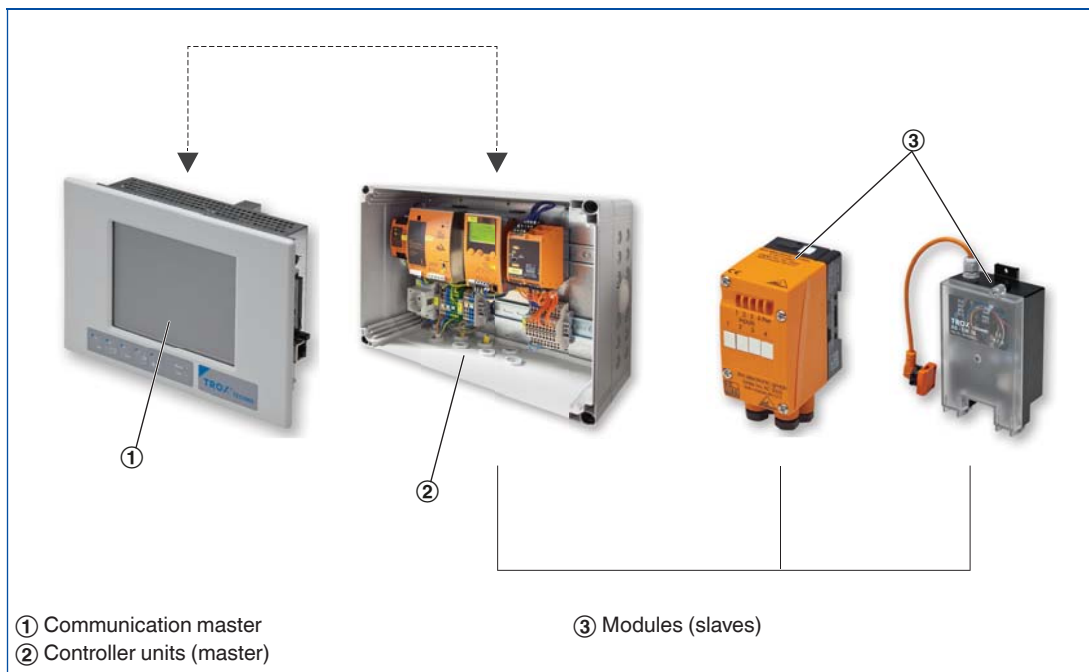

The communication master is the central display and control panel for the entire system.

- Connection of up to 28 controller and power units
- Display of operating status
- Operation of actuators
- Menu-driven operation in case of errors or malfunctions
- System configuration at the time of commissioning
- Logging of function tests and error messages

The controller and power unit combines the control functions, the power supply, and the data exchange for all components on the bus.

- The controller and power unit is installed near the modules, e.g. as a floor distributor
- With TNC Basic User Software for fire and smoke protection
- Communication interface to higher level systems (BACnet/Modbus)
- Display, also for operation
- Units with: 1 master – for 31 modules, 2 masters – for 62 modules

The modules establish the link between the measurement and control signals (sensors and actuators) and the network on the so-called field level. A module provides the supply voltage for the operation of actuators.

- Modules can be part of a fire damper or used separately to connect one or more fire dampers
- Integrated monitoring function, e.g. for running time
- Connection to the bus cable is with a flat cable insulation displacement connector

Description

LON indicates a standard local operating network system with manufacturer-independent communications. Data is transferred by a microprocessor supplied by Echelon Corporation using a unified protocol. LonMark defines standards to ensure product compatibility. TROX offers components that meet LON standards. TROX modules are characterised by a wide spectrum of functions yet simple cabling.

Special characteristics

- Data exchange and power supply can be achieved with just one cable
- Decentralised structure with high operational reliability
- Standardised data transfer
- Manufacturer-independent compatibility

The system

Network topology

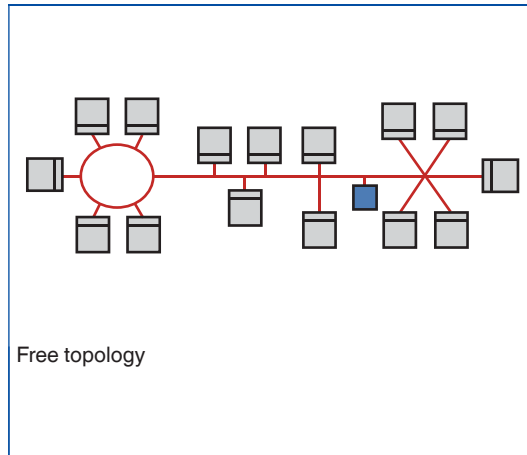

Network

The local operating level (subnet) consists of the modules (nodes) and free topology data cables. A subnet can consist of up to 64 nodes or, alternatively, can be extended to 128 nodes using a repeater or router. Physical data transfer is via systems with or without a transfer of supply voltage. All nodes of a subnet must comply with the system. In larger networks the routers link the subnets with each other. The routers communicate with each other via the backbone, on a separate network level. Central monitoring of a LON network is possible and is connected to the backbone or above it.

Binding network variables

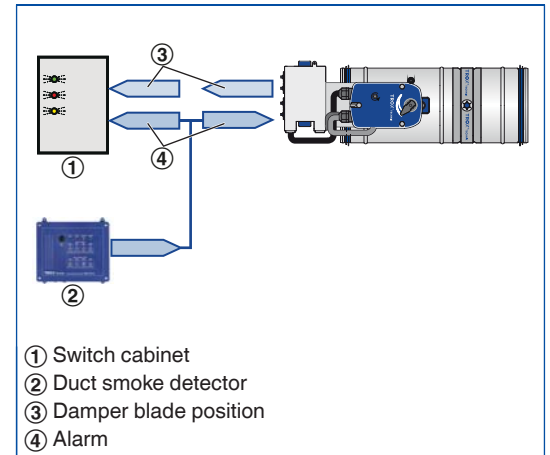

Data exchange

Network variables are used for the communication between the nodes. These variables ensure unambiguous data exchange between the nodes. For commissioning, it is necessary to link the network variables between the nodes (binding). Project software is used to link the outputs of a node to the inputs of other nodes. Binding information is transferred to the subnet. Binding is carried out by a system integrator.