

# Particulate filter modules for ceilings

## Type TFM



3

### For critical air purity and critical hygiene requirements, suitable for ceiling installation

Particulate filter modules as final filter stage with Mini Pleat filter panels for the separation of suspended particles. Use in laboratories, medical areas, or production rooms in the pharmaceutical and food industry.

- Individual casings can be combined to ceiling sections
- For air cleanliness classes 5 to 8 according to ISO 14644-1
- Easy, time-saving, and secure filter change due to special press-in frame
- With sealing integrity test facility for filter elements
- Equipment for differential pressure measurement
- Meets the hygiene requirements of VDI 6022



Tested to VDI 6022

Type		Page
TFM	General information	3.3 – 2
	Order code	3.3 – 3
	Dimensions and weight	3.3 – 4
	Specification text	3.3 – 5
	Basic information and nomenclature	10.1 – 1

### Description



3 Particulate filter modules for ceilings, type TFM

### Application

- Particulate filter module type TFM for ceiling installation as final filter stage and for air distribution in clean room technology
- Individual casings can be combined to ceiling sections
- Fitting of filter elements for the separation of suspended particles such as aerosols, toxic dusts, viruses and bacteria from the supply or extract air

### Nominal sizes [mm]

- B × L

### Useful additions

- Mini Pleat filter panels (MFP)
- Suitable filter elements to be ordered separately

### Special features

- Compact construction
- Extremely easy operation
- High operational reliability
- Individual casings can be combined to ceiling sections

### Construction features

- Clamping mechanism with 4 fixing points for filter elements
- Sealing integrity test facility for checking the filter function
- Pressure measurement points to monitor the differential operating pressure
- Spigot (circular, top entry)

### Materials and surfaces

- Casing made of sheet steel, powder-coated RAL 9010, pure white
- Diffuser face plate made of perforated sheet metal with perimeter return edge, powder-coated RAL 9010, pure white

### Installation and commissioning

- The filter elements are pressed into place using four easy-to-handle tensioning elements

### Standards and guidelines

- Hygiene meets the requirements of VDI 6022, VDI 3803, DIN 1946 Part 4, ÖNORM H 6021 and ÖNORM H 6020, SWKI VA 104-01 and SWKI 99-3, and EN 13779

### Maintenance

- Diffuser face plate for easy removal for filter change and decontamination

Order code

TFM

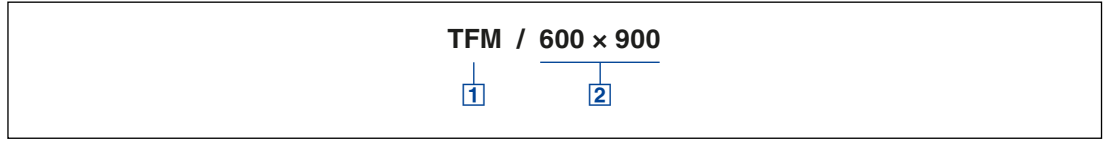

1 Type

TFM Particulate filter module

2 Nominal size [mm]

600 x 600

600 x 900

600 x 1200

Order example

TFM/600x900

Nominal size

600 x 900 mm

### Dimensions



Particulate filter modules for ceilings, type TFM

### Dimensional drawing of TFM

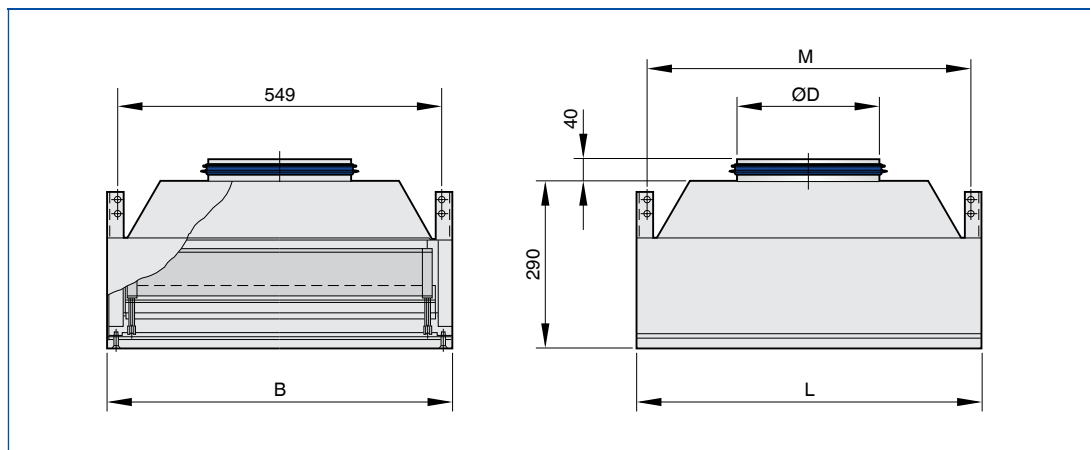

## 3

### Standard construction

All weights are net, without packaging.

### Dimensions [mm] and weight [kg]

Nominal size		Filter size	①	②	③
B	L	B × H × T	M	ØD	~ kg
600	600	535 × 535 × 78	549	248	22
600	900	835 × 535 × 78	849	313	27
600	1200	1135 × 535 × 78	1149	348	32

① Top suspension, distance between holes    ② Spigot diameter    ③ Weight

### Standard text

This specification text describes the general properties of the product. Texts for other variants can be generated with our Easy Product Finder design programme.

Particulate filter modules type TFM for ceiling installation as final filter stage and for air distribution in clean room technology. Individual casings can be combined into ceiling sections. Fitting of filter elements for the separation of suspended particles such as aerosols, toxic dusts, viruses and bacteria from the supply or extract air. Casing with top entry spigot. Particulate filter module with clamping mechanism with 4 fixing points for filter elements. As standard, the casings are equipped with a sealing integrity test facility and pressure measurement points for monitoring the operating differential pressure. For the fitting of Mini Pleat filter panels using a flat section seal. Diffuser face plate made of perforated sheet metal with perimeter return edge, powder-coated RAL 9010, pure white. Leakage test for each casing.

### Special features

- Compact construction
- Extremely easy operation
- High operational reliability
- Individual casings can be combined to ceiling sections

### Materials and surfaces

- Casing made of sheet steel, powder-coated RAL 9010, pure white
- Diffuser face plate made of perforated sheet metal with perimeter return edge, powder-coated RAL 9010, pure white

### Order options

#### 1 Type

**TFM** Particulate filter module

#### 2 Nominal size [mm]

- 600 × 600
- 600 × 900
- 600 × 1200

# Filter units and filter elements

## Basic information and nomenclature



- Selection of filter elements
- Test method according to EN 779
- Eurovent certification
- Energy efficiency according to Eurovent document 4/11
- Test method according to EN 1822
- Easy Product Finder
- New product names

# Filter units and filter elements

## Basic information and nomenclature

	Filter class	Construction	Area of application	Examples
<b>Coarse dust filter, particle size &gt; 10 µm</b>				
Insects, textile threads, sand, flue ash, pollen, spores, cement dust, carbon dust	G3 G4	Type FMC (Automatic roll filter media)	Prefilters and recirculated air filters	Civilian shelters
		Type FMR (roll media made of glass fibres or chemical fibres)	Extract air	Paint spray booths and kitchen extract air
		Type FMP (filter medium as roll media or cut-to-size pads)	Used to protect air handling units and compact units from contamination	Room air conditioners, fans
		Type ZL (Z-line filters) Type PFC (pocket filters made of non-woven chemical fibres)	Prefilters	For filter classes M5 to F9
<b>Fine dust filters, particle size 1 – 10 µm</b>				
Pollen, spores, cement dust, bacteria and germs Aerosol insecticides	M5 M6 F7	Type FMR (roll media made of chemical fibres)	Fresh air filters for rooms with low requirements	Factory buildings, storage rooms, and garages
		Type FMP (filter medium as roll media or cut-to-size pads)	Prefilters and recirculated air filters	Ventilation plant rooms
		Type ZL (Z-line filters) Type PFC (pocket filters made of non-woven chemical fibres) Type PFS (pocket filters made of non-woven synthetic fibres)	Final filters in air conditioning systems	Sales rooms, department stores, offices
Oil spray and accumulated soot, tobacco smoke, metal oxide smoke	F7 F8 F9	Type PFG (pocket filters made of non-woven glass fibres)	Prefilters in air conditioning systems	For filter classes F7 to F9
		Type PFN (pocket filters made of NanoWave® medium)	Final filters in air conditioning systems	Offices, production rooms, central control rooms, hospitals, computer centres
		Type MFI (Mini Pleat filter inserts) Type MFE (Mini Pleat filter elements) Type MFC (Mini Pleat filter cells) Type MFP (Mini Pleat filter panels) Type DFF (Deep Pleat compact fine dust filter)	Prefilters	For filter classes E11, E12 and H13
<b>Particulate filters, particle size &lt; 1 µm</b>				
Bacteria and viruses tobacco smoke metal oxide smoke asbestos dust	E10 E11 H13	Type MFI (Mini Pleat filter inserts) Type MFE (Mini Pleat filter elements) Type MFC (Mini Pleat filter cells) Type MFP (Mini Pleat filter panels) Type DFH (Deep Pleat particulate filter cells)	Final filters for the most critical requirements	Laboratories, production rooms in the food processing and pharmaceutical industries
				Fine-mechanical, optical, and electronic industries
				Medicine
<b>Particulate filters for clean room technology</b>				
Particle size < 1 µm see Particulate filters	H13	Type MFI (Mini Pleat filter inserts) Type MFE (Mini Pleat filter elements) Type MFC (Mini Pleat filter cells) Type MFP (Mini Pleat filter panels) Type DFH (Deep Pleat particulate filter cells)	Final filters	For rooms rated to an ISO class between 7 and 9, or class 10000 or 100000 according to Federal Standard
Various stages of oil vapour and soot suspended radioactive particles	H14	Type MFI (Mini Pleat filter inserts) Type MFC (Mini Pleat filter cells) Type MFP (Mini Pleat filter panels)		For rooms rated to an ISO class between 5 and 7, or class 100, 1000 or 10000 according to Federal Standard
Aerosols	H14 U15 U16	Type MFPCR (Mini Pleat filter panels for clean room technology)		For rooms rated to an ISO class between 1 and 4, or class 1 or 10 according to Federal Standard

### Test method



Pocket filter, type PFG



Mini Pleat filter insert  
type MFI, construction PLA



Mini Pleat filter panel  
type MFP

### EN 779 – test method

Coarse and fine dust filters are used for separating contaminants from the atmospheric air for general use in ventilation and air conditioning systems as well as in process engineering.

For the testing of coarse and fine dust filters, European standard EN 779, 'Particulate air filters for general ventilation', describes a uniform, reproducible test method, the requirements for particulate filters, and the test rig for measurement.

### Measurement of the initial differential pressure

The initial differential pressure is the differential pressure of the clean sample. It is measured at least at 50 %, 75 %, 100 %, and 125 % of the nominal volume flow rate to which the filter is subjected. The measurement results are used to create a curve of the differential pressure as a function of the volume flow rate.

### Measurement of the arresstance

For the determination of the arresstance, synthetic dust (ASHRAE dust) is fed at increments at nominal volume flow rate. The composition of the synthetic test dust is based on weight percentages of the following:

- 72 weight percent of 'fine' test dust to ISO 12103-1 A2
- 23 weight percent of black carbon
- 5 weight percent of lint cotton

Downstream of the sample, a final filter takes up the dust that has not been arrested by the sample. From the weight gain of the final filter and the amount of dust fed, the arresstance is determined gravimetrically, i.e. by weighing the final filter after every dust feed procedure. Every dust feed results in an increase of the differential pressure of the filter. The test is continued until the final differential pressure defined in the standard is reached.

The maximum final differential pressure is 250 Pa for coarse dust filters, and 450 Pa for fine dust filters.

Then the average arresstance for the entire duration of the test is calculated.

### Calculation of the dust holding capacity

The dust holding capacity is the product of the total mass of dust fed and the average arresstance.

### Measurement of the efficiency

For fine dust filters, the efficiency is measured together with the arresstance.

First, the initial efficiency of the clean filter is determined. The efficiency is then measured again after each measurement of the arresstance. To determine the efficiency, the sample is treated with a test aerosol made of DEHS (di-ethyl-hexyl sebacate). The efficiency is determined at the beginning and directly after each dust feed (ASHRAE test dust) by counting particles. The particle counter used can count particles as small as 0.1  $\mu\text{m}$ .

For the test, an aerosol made of DEHS and with a particle size of 0.2 – 3.0  $\mu\text{m}$  is mixed with the test air. Upstream and downstream of the filter, partial airflows are sampled and fed to the particle counter. The test is stopped at a final differential pressure of 450 Pa. Finally, the average efficiency for the entire duration of the test is calculated.

The classifying particle size is 0.4  $\mu\text{m}$ .

### Efficiency after electrostatic discharge

Certain synthetic filter media rely on electrostatic effects to achieve a high efficiency. Since electrostatic charges can be neutralised by some contaminants in the air, the efficiency of a filter is also determined after a complete discharge.

For this purpose, the IPA test method (isopropanol treatment) is described in detail in the EN 779:2012 standard. The process is such that representative samples from the filter to be tested are dipped in isopropanol, dried, and then the efficiency is measured with a particle size of 0.4  $\mu\text{m}$ .



**EN779:2012 AIR FILTER RESULTS**

① GENERAL				
Test no.: SP201103101	Date of test: 08/03/2011 - 11/03/2011		Supervisor: CM/TER	
Test requested by: TROX GmbH		Device receiving date		
Device delivered by: TROX GmbH		07/03/2011		
② DEVICE TESTED				
Model: PFN-F7-GAL-25		Manufacturer: TROX GmbH	Construction: Pocket filter, 8 pockets	
Type of media: Synthetic		Net effective filtering area: 6.4 m <sup>2</sup>	Filter dimensions (width x height x depth): 592 mm x 592 mm x 600 mm	
③ TEST DATA				
Test air flow rate: 0.944 m <sup>3</sup> /s	Test air temperature: 28 to 33 °C	Test air relative humidity: 11 to 18 %	Test aerosol: DEHS	Loading dust: ASHRAE 52/76
④ RESULTS				
Initial pressure drop: 93 Pa	Initial arrestance: >99 %	Initial efficiency (0.4 µm): 44 %	Test dust capacity: 217 / 353 / 480 g	Untreated/ discharged efficiency of media (0.4 µm): 46.5 % / 39,8 %
Final test pressure drop: 250 / 350 / 450 Pa	Average arrestance: >99% / >99% / >99%	Average efficiency (0.4 µm): 85% / 90% / 93%	Filter class (450 Pa): F7	Remarks:
Note: The performance results are only valid for the tested item and cannot by themselves be quantitatively applied to predict efficiency and lifetime in service				

10

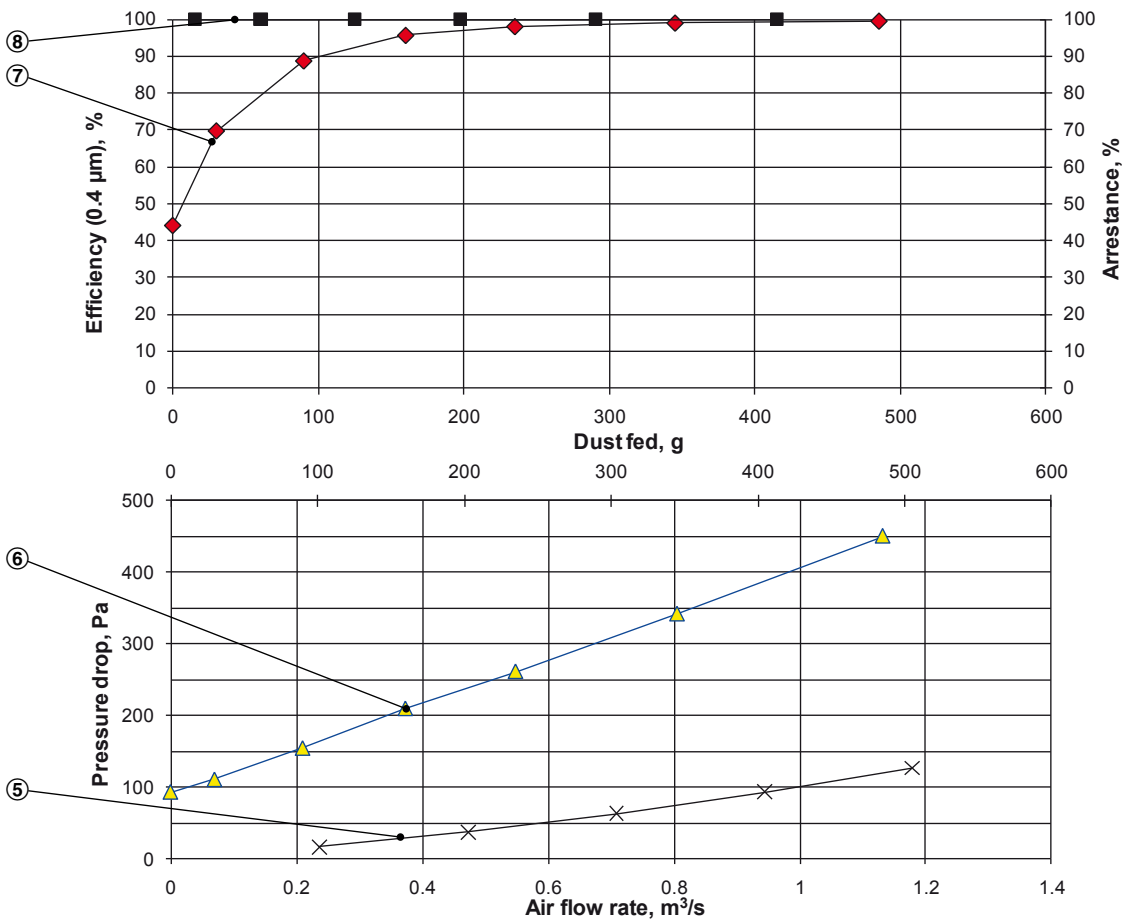

- ① General information
- ② Information on the tested filter
- ③ Test data
- ④ Test results
- ⑤ Differential pressure as a function of the volume flow rate (clean sample)

- ⑥ Differential pressure as a function of the dust fed at the test volume flow rate
- ⑦ Efficiency (0.4µm) as a function of the dust fed at the test volume flow rate
- ⑧ Filtration efficiency as a function of the dust fed at the test volume flow rate

**Classification**

The new EN 779:2012 standard now requires specific minimum efficiencies for filter classes F7 to F9.

No minimum efficiency is required for filter classes F5 and F6. To differentiate them from filter classes F7, F8 and F9, the new filter group M has been created. The filters continue to be classified based on the average efficiency.

Group	Filter class	Final differential pressure	Average arrestance (Am) of the synthetic test dust	Average efficiency (Em) for particles of 0.4 µm	Minimum efficiency for particles of 0.4 µm
		Pa	%		
Coarse	G1	250	50 ≤ Am < 65	–	–
Coarse	G2	250	65 ≤ Am < 80	–	–
Coarse	G3	250	80 ≤ Am < 90	–	–
Coarse	G4	250	90 ≤ Am	–	–
Medium	M5	450	–	40 ≤ Em < 60	–
Medium	M6	450	–	60 ≤ Em < 80	–
Fine	F7	450	–	80 ≤ Em < 90	35
Fine	F8	450	–	90 ≤ Em < 95	55
Fine	F9	450	–	95 ≤ Em	70

### Eurovent certification



### Objective and contents

The objective of the certification programme is the creation of shared databases with data on the technical properties of air filters that are tested by independent organisations. These independent organisations check whether the data given in a manufacturer's catalogue corresponds to the actual results of filter tests.

Once a sample product has been successfully tested by an independent organisation, the resulting certification applies to the defined product range and applications.

Certification is officially performed by the Eurovent Certification Company.

In addition to the certification number, the EUROVENT logo may be used.

Usually filters of classes M5 to F9 are tested. The tests are performed by independent, accredited testing institutes. For filters, these are VTT in Finland and SP in Sweden.

### Quality management as a prerequisite for participation

Participation in the Eurovent certification programme is voluntary. Manufacturers who want to have their filter portfolio certified must have a quality management system such as ISO 9001.

### Random selection of samples

Once a year, Eurovent selects one filter to be tested from four different product groups for each manufacturer. Product groups and the respective filters are selected at random.

### The certificate

If all four filters have successfully passed the test, Eurovent provides the manufacturer with a certificate that is valid for one year. The certificate applies to all fine dust filters of the manufacturer (the 'certify all' principle). The tests are repeated every year.



### Energy efficiency according to Eurovent document 4/11

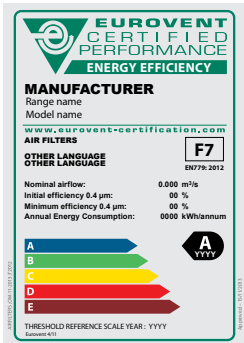

### The energy label makes the decision easy

The energy consumption of ventilation systems is decisive for the economic efficiency of the entire building. Filters have a great influence on the energy consumption of ventilation systems since they generate differential pressures that have to be compensated by an increase in the energy supply. Up to 80% of the costs for air filtration are energy costs. This is why every facilities manager would like to know about the energy efficiency of filters.

Eurovent document 4/11 describes a uniform method to evaluate the energy efficiency of filter classes G4, M5, M6, and F7 to F9.

### Practical calculation of the average differential pressure

The average differential pressure is calculated according to EN 779 as a function of the dust feed at the test volume flow rate.

Based on the measuring results, the average differential pressure is calculated using the following formula: fit fourth degree polynomial. In the process, filter group G filters are fed with 350 g of ASHRAE dust, group M filters with 250 g, and group F filters with 100 g. This corresponds to the average dust load of the filter in one year of operation.

### What do the energy classes mean?

There are seven energy classes (A to G). Class A filters are particularly energy-efficient. Class G filters, on the other hand, have a comparatively high energy consumption.

### Which filters may carry the energy label?

The Eurovent energy label applies to filters of classes G4 to F9 which are tested to the EN 779:2012 standard. It can only be used by manufacturers whose filters are certified by Eurovent.

### Environmental protection and economic efficiency

The energy classification according to Eurovent is a reliable method for realistically estimating the energy consumption of filters in all kinds of systems. It is recognised by all important European manufacturers and represents an important contribution to the reduction of energy consumption and CO<sub>2</sub> emissions.

### Calculation of the average differential pressure

$$\overline{\Delta p} = \frac{1}{M} \int_0^M \Delta p(m) \times d(m) = \frac{1}{5}a \times M^4 + \frac{1}{4}b \times M^3 + \frac{1}{3}c \times M^2 + \frac{1}{2}d \times M + \Delta p_i$$

### Calculation of the energy consumption for a filter

$$W = \frac{q_v \times \overline{\Delta p} \times t}{\eta \times 1000}$$

W: Energy consumption  
 q<sub>v</sub>: Volume flow rate  
 Δp: Average differential pressure  
 t: Operating time  
 η: Fan efficiency  
**Given data**  
 q<sub>v</sub> = 0.944 m<sup>3</sup>/s  
 t = 6000 h  
 η = 0.50

Eurovent limits for the energy classification of filters

Filter class	G4	M5	M6	F7	F8	F9
MTE	-			MTE ≥ 35 %	MTE ≥ 55 %	MTE ≥ 70 %
	M <sub>G</sub> = 350 g ASHRAE	M <sub>M</sub> = 250 g ASHRAE		M <sub>F</sub> = 100 g ASHRAE		
	kWh					
A	0 – 600	0 – 650	0 – 800	0 – 1200	0 – 1600	0 – 2000
B	>600 – 700	>650 – 780	>800 – 950	>1200 – 1450	>1600 – 1950	>2000 – 2500
C	>700 – 800	>780 – 910	>950 – 1100	>1,450 – 1700	>1950 – 2300	>2500 – 3000
D	>800 – 900	>910 – 1040	>1100 – 1250	>1700 – 1950	>2300 – 2650	>3000 – 3500
E	>900 – 1000	>1040 – 1170	>1250 – 1400	>1950 – 2200	>2650 – 3000	>3500 – 4000
F	>1000 – 1100	>1170 – 1300	>1400 – 1550	>2200 – 2450	>3000 – 3350	>4000 – 4500
G	>1100	>1300	>1550	>2450	>3350	>4500

MTE: Minimum test efficiency

Calculation of the average differential pressure

$$\bar{\Delta p} = \frac{1}{M_0} \int \Delta p(m) \times d(m) = \frac{1}{5} a \times M^4 + \frac{1}{4} b \times M^3 + \frac{1}{3} c \times M^2 + \frac{1}{2} d \times M + \Delta p_i$$

Example: Calculation of average differential pressure and energy consumption

10

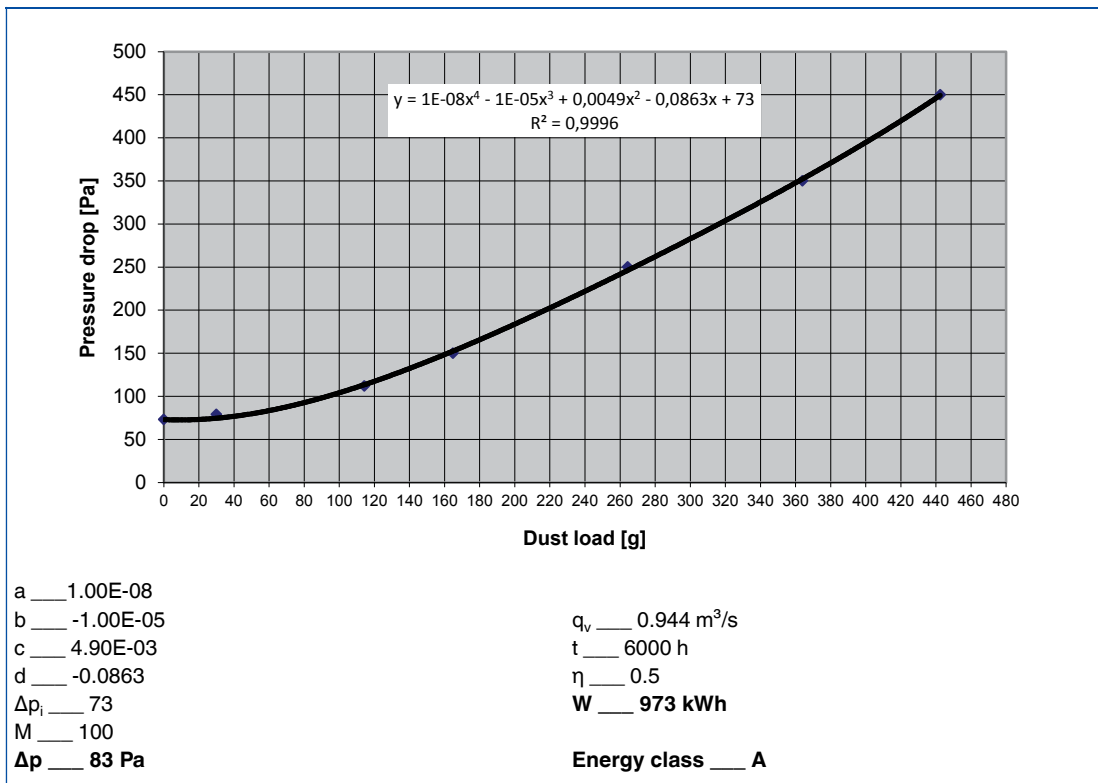



Mini Pleat filter panels for clean room technology, type MFPCR



Mini Pleat filter cells, type MFC

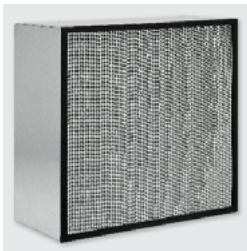

Deep Pleat particulate filter cells, type DFH

**EN 1822 – test method**

The EN 1822 standard applies to tests for the filtration performance of efficient particulate air filters (EPA), high-efficiency particulate air filters (HEPA) and ultra low penetration air filters (ULPA) in the manufacturer's production facility. The European EN 1822 standard was first published in 1998 and last revised in 2011. The standard consists of five parts.

It defines a method for testing the efficiency by counting particles using a liquid or solid test aerosol. The test aims at determining the particle size at which the filter shows its minimum filtration efficiency.

This particle size is called the 'most penetrating particle size, or MPPS'. As a rule, particulate filters with glass fibre papers can separate particles as small as 0.1 to 0.25 µm.

**Part 1 – Classification, performance test, and labelling**

Part 1 of the standard deals with the classification, performance testing, and labelling of particulate filters. On the basis of the values for local efficiency and overall efficiency, the filter is assigned to a filter class according to the table below.

Filter class	Overall		Local	
	Efficiency	Penetration	Local efficiency	Local penetration
%				
E10	≥ 85	≤ 15	–	–
E11	≥ 95	≤ 5	–	–
E12	≥ 99.5	≤ 0.5	–	–
H13	≥ 99.95	≤ 0.05	≥ 99.75	≤ 0.25
H14	≥ 99.995	≤ 0.005	≥ 99.975	≤ 0.025
U15	≥ 99.9995	≤ 0.0005	≥ 99.9975	≤ 0.0025
U16	≥ 99.99995	≤ 0.00005	≥ 99.99975	≤ 0.00025
U17	≥ 99.999995	≤ 0.000005	≥ 99.99999	≤ 0.0001

**Part 2 – Measuring devices and aerosol generators**

Part 2 of the standard describes the measuring devices and aerosol generators used for the test. It also explains the statistical basis for particle counting in cases where the testing equipment registers only very few counts.

**Part 3 – Determination of fractional efficiency and MPPS**

Part 3 of the standard describes how the fractional efficiency and the MPPS are determined. The flat sheet filter medium is fixed in a frame and subjected to the test air flow. The test air flow contains a test aerosol. Upstream and downstream of the filter, partial air flows are sampled in order to determine the concentration of particles of various sizes. The results of the measurement are shown as a fractional efficiency curve. The particle size with the highest penetration is known as MPPS.



Test rig EN 1822-4

#### Part 4 – Leakage test, determination of local efficiency and overall efficiency

Part 4 of the standard is dedicated to the leakage testing of filter elements using a scan test.

With a test aerosol whose average particle size equals the MPPS, the filter element is checked for leakage. The overall efficiency is calculated from the measured local filtration efficiencies. The leakage test serves to test the filter element for local penetration values that exceed the permissible levels.

For the leakage test, the test filter is fixed in a mounting assembly and subjected to a test air flow that is equal to the nominal volume flow rate. After the measurement of the differential pressure at the nominal volume flow rate, the filter is purged and the test aerosol produced by the aerosol generator is mixed with the prepared test air along a mixing duct such that it is spread homogeneously over the cross-section of the duct.

The particle flow rate on the downstream side of the tested filter is smaller than the particle flow

rate on the upstream side by the factor mean penetration.

Downstream of the filter, the manufacturing irregularities of the filter material or leaks in the filter material lead to a variation of the particle flow rate over the filter cross section. In addition, leaks at the edges of the filter or within the components of the test filter (sealant, filter frame, seal of the filter mounting assembly) may lead locally to an increase in the particle flow rate on the downstream side of the test filter.

During the leakage test, the particle flow distribution on the downstream side of the filter is determined to check if and where the limit values are exceeded. For this purpose a measuring probe is connected to the downstream particle counters.

When the filter is leak-free and fulfils the criteria of the overall efficiency, a test report is created. The test report contains the test number, the target data for the filter, and the actual data of the sample. The leak-free state of the filter is confirmed, and the filter is assigned a number .

#### Test rig EN 1822-4



#### Repair of leakage points

If the specified signal value is not exceeded during the probe run, the filter is free of leaks. If the signal value is exceeded, then this is an indication that the limit value for locally permissible penetration has been exceeded at this position. Should it be necessary to check the local penetration, then the probe is returned to the coordinates at which the signal values were reached in the scan test. The aim is to find the point with the maximum count rate.

At that point the count rate is measured with a stationary probe. At the same time the concentration of the aerosol on the upstream side is also measured continuously or intermittently. The filter may be repaired when the following

parameters apply. The filter shall be retested after repair.

» All repairs in total (including those made by the filter manufacturer) must neither block nor restrict more than 0.5 % of the filter face area (not including the frame).

» The maximum length of each repair point must not exceed 3.0 cm.

#### Part 5 Efficiency test of the filter element

The last part of the standard deals with the efficiency test of filter elements that could not be tested according to Part 4 due to their design. The downstream sampling to determine the overall efficiency takes place using stationary sampling probes.



### Sizing example

### Mini Pleat filter panels for clean room technology, type MFPCR

#### Sizing data

- Filter class \_\_\_\_\_ H14
- Volume flow rate \_\_\_\_\_ 1205 [m<sup>3</sup>/h]
- Initial differential pressure \_\_\_\_\_ 85 [Pa]
- Nominal size \_\_\_\_\_ 1220 x 610 [mm]
- Pleat depth \_\_\_\_\_ 70 [mm]

#### Construction

- ALG: Frame made of extruded aluminium profile (depth 90 mm)

### Easy Product Finder

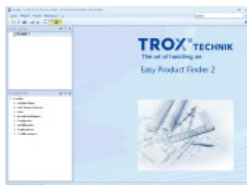

The Easy Product Finder allows you to size products using your project-specific data.

You will find the Easy Product Finder on our website.

### MFPCR\_EasyProductFinder

The screenshot shows the software interface with the following input parameters:

- Neue Position: Bestellschlüssel: MFPCRXX
- Produktauswahl: Ausführung (Aluminiumprofil selected)
- Abmessungen: Breite 1.220 mm (305...1830), Höhe 610 mm (305...1220)
- Faltenhöhe: Faltenhöhe 70 mm (50...120)
- Volumenstrom: Volumenstrom 1.205 m<sup>3</sup>/h (0...7132)

On the right, there is a 'Produktfoto' section showing a photograph of the filter panel.

The 'Ergebnisse' section contains a table with the following data:

Details	Diagramm Druckdifferenz	Diagramm Durchlassgrad	50%	60%	70%	80%	90%	100%	110%	120%
Anteil vom Volumenstrom in %			50%	60%	70%	80%	90%	100%	110%	120%
Volumenstrom [m <sup>3</sup> /h]			602	723	844	964	1084	<b>1205</b>	1325	1446
Anfangsdruckdifferenz [Pa]			43	51	60	69	78	<b>87</b>	97	106
Abscheidegrad [%]			99,9987	99,9987	99,9986	99,9985	99,9983	<b>99,9980</b>	99,9977	99,9972

#### Sizing results

- Initial differential pressure: \_\_\_\_\_ 87 [Pa]
- Overall efficiency: \_\_\_\_\_ 99.9980 [%]
  
- Requirement for filter class H14:
- Overall efficiency: \_\_\_\_\_ >99.995 [%]



### Sizing example

### Ceiling mounted particulate filters, type TFC

#### Sizing data

- Variant \_\_\_\_\_ SC
- Material \_\_\_\_\_ Casing SPC
- Air terminal device \_\_\_\_\_ VDW
- Nominal size \_\_\_\_\_ 600 × 24
- Spigot diameter \_\_\_\_\_ 248 mm
- Casing height \_\_\_\_\_ 344 mm
- Damper blade \_\_\_\_\_ M
- Fixing points \_\_\_\_\_ 2
- Suspension/measurement points \_\_\_\_\_ S
- Flange width \_\_\_\_\_ 15 mm
- Volume flow rate \_\_\_\_\_ 600 m<sup>3</sup>/h
- Required sound power level \_\_\_\_\_ 40 dB(A)

#### Selection of Mini Pleat filter panel

- MFP-H13-ALU/535×535×91×50

### Easy Product Finder

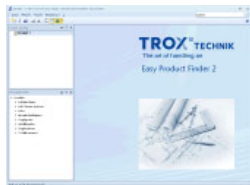

The Easy Product Finder allows you to size products using your project-specific data.

You will find the Easy Product Finder on our website.

### TFC\_EasyProductFinder

[Projekt 1] - TROX Easy Product Finder - Standort des Projektes: Deutschland - Preisliste: 2013

Datei Ansicht Projekt Assistenten ?

Neue Position: Bestellschlüssel

TFC-SC-SPC-VDW / 600x24x248x344 / M / 2 / S / 15

Produktauswahl Zeichnung Bestelldetails

Volumenstrom  
Volumenstrom  m<sup>3</sup>/h (216...900)

Zwischenräume/Abstände [m]

A	<input type="text" value="1,20"/>	(≥0,8)
H <sub>1</sub>	<input type="text" value="1,20"/>	(0,9...2,0)
X	<input type="text" value="3,00"/>	(≥1,2)
B	<input type="text" value="0,00"/>	

L = H<sub>1</sub> + X = 4,20

Enreihige Anordnung

Temperaturunterschied [K]

Δt<sub>r</sub>  (-12,0...+4,0)

Geeignete Filtermedien

MFP-H13-ALU / 535x535x91x50 (Rahmen aus Aluminium-Strangpressprofil (Tiefe 91mm))

Ergebnisse

v <sub>st</sub>	0,24	m/s
Δt <sub>st</sub>	-0,7	K
v <sub>L</sub>	0,26	m/s
Δt <sub>L</sub>	0,2	K
Filterbreite	535	mm
Filterhöhe	535	mm
Filtertiefe	91	mm

Anwendung/Foto/Video

TFC-SC VDW

Produktfoto

Akustische Ergebnisse

Zuluft			
Bezeichnung	Wert	Maßeinheiten	
dpt	193	Pa	
LWA	37	dB(A)	
LWNC	30		

#### Sizing results

- Total differential pressure: \_\_\_\_\_ 193 [Pa]
- Sound power level: \_\_\_\_\_ 37 [dB(A)]

New product names for filter units

①	②	③	④	
F210	SCF	C	Filter frames for wall installation	Standard cell frames
F220	SCF	B	Filter frames for wall installation	Standard cell frames
F240	SCF	B	Filter frames for wall installation	Standard cell frames
F242	SCF	A	Filter frames for wall installation	Standard cell frames
F250	MF	-	Filter frames for wall installation	Mounting frames
F270	MP	-	Filter frames for wall installation	Mounting plate
F340	UCA	1SPF	Filter casings for duct installation	Universal casings
F341	UCA	1SAF	Filter casings for duct installation	Universal casings
F344	UCA	2SPF	Filter casings for duct installation	Universal casings
F345	UCA	2SAF	Filter casings for duct installation	Universal casings
F353	KSF	-	Filter casings for duct installation	Ducted particulate filters
F360	KSFS	M	Filter casings for duct installation	Ducted particulate filters for critical requirements
F370	KSFS	PM	Filter casings for duct installation	Ducted particulate filters for critical requirements
F352	KSF	-	Filter casings for duct installation	Ducted particulate filters
F383	DCA	-	Filter casings for duct installation	Duct casings for particulate filters
F620	TFP	TC	Particulate filter air terminal devices	Pharmaceutical clean room terminal filters
F622	TFP	SC	Particulate filter air terminal devices	Pharmaceutical clean room terminal filters
F624	TFP	SCR	Particulate filter air terminal devices	Pharmaceutical clean room terminal filters
F631	TFM	-	Particulate filter air terminal devices	Particulate filter modules for ceilings
F640	TFC	SC	Particulate filter air terminal devices	Ceiling mounted particulate filters
F650	TFC	SR	Particulate filter air terminal devices	Ceiling mounted particulate filters
F654	TFC	SC00H	Particulate filter air terminal devices	Ceiling mounted particulate filters
F655	TFC	SCTN0	Particulate filter air terminal devices	Ceiling mounted particulate filters
F656	TFC	SCBR0	Particulate filter air terminal devices	Ceiling mounted particulate filters
F659	TFC	SCVFL	Particulate filter air terminal devices	Ceiling mounted particulate filters
F660	TFC	TC	Particulate filter air terminal devices	Ceiling mounted particulate filters
F670	TFW	-	Particulate filter air terminal devices	Wall mounted particulate filter
M536AB3	MD	DPC/230	Measuring devices	Pressure measuring devices
M536AB4	MD	DPC/24	Measuring devices	Pressure measuring devices
M536AC4	MD	APC	Measuring devices	Pressure measuring devices
M536AD4	MD	UT	Measuring devices	Pressure measuring devices
New type	SIF	B	Filter frames for wall installation	Filter wall
	KSFSSP	-	Filter casings for duct installation	Spigots
New variant	TFC	SRKSR	Particulate filter air terminal devices	Ceiling mounted particulate filters

① Previous name ② New name ③ Variant ④ Product

New product names for filter elements

①	②	③	④	⑤	
F702A...	FMC	G02-CAS	G3	Automatic roll filter media	Filter media
F702B...	FMR	G02	G3	Roll media	Filter media
F702B...	FMP	G02-ROL	G3	Cut-to-size pads	Filter media
F702C...	FMC	G02-RFMS/RFMA	G3	Automatic roll filter media	Filter media
F702D...	FMP	G02-PAD	G3	Cut-to-size pads	Filter media
F702N...	FMC	G02-CASN	G3	Automatic roll filter media	Filter media
F703B...	FMP	C03-ROL	G3	Cut-to-size pads	Filter media
F703B...	FMR	C03	G3	Roll media	Filter media
F703D...	FMP	C03-PAD	G3	Cut-to-size pads	Filter media
F704B...	FMR	C04	G3	Roll media	Filter media
F704B...	FMP	C04-ROL	G3	Cut-to-size pads	Filter media
F704D...	FMP	C04-PAD	G3	Cut-to-size pads	Filter media
F706B...	FMR	C06	M5	Roll media	Filter media
F706B...	FMP	C06-ROL	M5	Cut-to-size pads	Filter media
F706D...	FMP	C06-PAD	M5	Cut-to-size pads	Filter media
F711B...	FMR	C11	G4	Roll media	Filter media
F711B...	FMP	C11-ROL	G4	Cut-to-size pads	Filter media
F711D...	FMP	C11-PAD	G4	Cut-to-size pads	Filter media
F715B...	FMR	C15	G4	Roll media	Filter media
F715B...	FMP	C15-ROL	G4	Cut-to-size pads	Filter media
F715D...	FMP	C15-PAD	G4	Cut-to-size pads	Filter media
F718E...	ZL	NWO	G4	Z-Line filters	Filter media
F718K...	ZL	PLA	G4	Z-Line filters	Filter media
F719E...	ZL	NWO	M5	Z-Line filters	Filter media
F719K...	ZL	PLA	M5	Z-Line filters	Filter media
F721A...	FMC	C21-CAS	G3	Automatic roll filter media	Filter media
F721C...	FMC	C21-RFMA/RFMD	G3	Automatic roll filter media	Filter media
F725...	PFS	PLA, GAL	M5	Pocket filters made of non-woven synthetic fibres	Pocket filter
F726...	PFS	PLA, GAL	M6	Pocket filters made of non-woven synthetic fibres	Pocket filter
F728...	PFS	PLA, GAL	F7	Pocket filters made of non-woven synthetic fibres	Pocket filter
F736G...	DFF	GALSF/SMG/HMG	M6	Compact fine dust filters	Deep Pleat filters
F736M...	DFF	GALSF	M6	Compact fine dust filters	Deep Pleat filters
F736W...	DFF	MDF	M6	Compact fine dust filters	Deep Pleat filters
F736X...	DFF	GALDF/SMG/HMG	M6	Compact fine dust filters	Deep Pleat filters
F736Y...	DFF	GAL	M6	Compact fine dust filters	Deep Pleat filters
F737M...	DFF	GALSF	F7	Compact fine dust filters	Deep Pleat filters
F737W...	DFF	MDF	F7	Compact fine dust filters	Deep Pleat filters
F737Y...	DFF	GAL	F7	Compact fine dust filters	Deep Pleat filters
F739G...	DFF	GALSF/SMG/HMG	F9	Compact fine dust filters	Deep Pleat filters
F739M...	DFF	GALSF	F9	Compact fine dust filters	Deep Pleat filters
F739W...	DFF	MDF	F9	Compact fine dust filters	Deep Pleat filters
F739X...	DFF	GALDF/SMG/HMG	F9	Compact fine dust filters	Deep Pleat filters
F739Y...	DFF	GAL	F9	Compact fine dust filters	Deep Pleat filters

① Previous name ② New name ③ Construction ④ Filter class ⑤ Product

## New product names for filter elements

①	②	③	④	⑤	
F743...	PFC	PLA, GAL	G4	Pocket filters made of non-woven chemical fibres	Pocket filter
F744...	PFG	PLA, GAL	M5	Pocket filters made of non-woven glass fibres	Pocket filter
F746...	PFG	PLA, GAL	M6	Pocket filters made of non-woven glass fibres	Pocket filter
F748...	PFG	PLA, GAL	F7	Pocket filters made of non-woven glass fibres	Pocket filter
F749...	PFG	PLA, GAL	F9	Pocket filters made of non-woven glass fibres	Pocket filter
F755F...	MFI	PLA	M5	Filter inserts	Mini Pleat filters
F755K...	MFP	PLA	M5	Filter panels	Mini Pleat filters
F755M...	MFI	SPC	M5	Filter inserts	Mini Pleat filters
F755S...	MFI	SPC	M5	Filter inserts	Mini Pleat filters
F756E...	MFC	STA	M6	Filter cells	Mini Pleat filters
F756E...	MFP	STA	M6	Filter panels	Mini Pleat filters
F756F...	MFI	PLA	M6	Filter inserts	Mini Pleat filters
F756K...	MFP	PLA	M6	Filter panels	Mini Pleat filters
F756M...	MFI	SPC	M6	Filter inserts	Mini Pleat filters
F756M...	MFC	GAL	M6	Filter cells	Mini Pleat filters
F756M...	MFP	GAL	M6	Filter panels	Mini Pleat filters
F756S...	MFI	SPC	M6	Filter inserts	Mini Pleat filters
F756W...	MFC	MDF	M6	Filter cells	Mini Pleat filters
F756W...	MFP	MDF/MDFF	M6	Filter panels	Mini Pleat filters
F757E...	MFC	STA	F7	Filter cells	Mini Pleat filters
F757E...	MFP	STA	F7	Filter panels	Mini Pleat filters
F757F...	MFI	PLA	F7	Filter inserts	Mini Pleat filters
F757K...	MFP	PLA	F7	Filter panels	Mini Pleat filters
F757M...	MFI	SPC	F7	Filter inserts	Mini Pleat filters
F757M...	MFC	GAL	F7	Filter cells	Mini Pleat filters
F757M...	MFP	GAL	F7	Filter panels	Mini Pleat filters
F757S...	MFI	SPC	F7	Filter inserts	Mini Pleat filters
F757W...	MFC	MDF	F7	Filter cells	Mini Pleat filters
F757W...	MFP	MDF/MDFF	F7	Filter panels	Mini Pleat filters
F759A...	MFE	AL	F9	Filter elements	Mini Pleat filters
F759E...	MFC	STA	F9	Filter cells	Mini Pleat filters
F759E...	MFP	STA	F9	Filter panels	Mini Pleat filters
F759F...	MFI	PLA	F9	Filter inserts	Mini Pleat filters
F759K...	MFP	PLA	F9	Filter panels	Mini Pleat filters
F759M...	MFI	SPC	F9	Filter inserts	Mini Pleat filters
F759M...	MFE	GAL	F9	Filter elements	Mini Pleat filters
F759M...	MFC	GAL	F9	Filter cells	Mini Pleat filters
F759M...	MFP	GAL	F9	Filter panels	Mini Pleat filters
F759S...	MFI	SPC	F9	Filter inserts	Mini Pleat filters
F759W...	MFC	MDF	F9	Filter cells	Mini Pleat filters
F759W...	MFP	MDF/MDFF	F9	Filter panels	Mini Pleat filters
F760E...	ACFC	STA		Filter cartridges	Activated carbon filters
F760F...	ACFI	PLA	-	Filter inserts	Activated carbon filters
F760J...	ACF			Filter cells	Activated carbon filters
F760K...	ACFC	PLA		Filter cartridges	Activated carbon filters
F760M...	ACFC	GAL		Filter cartridges	Activated carbon filters
F766...	PFN	PLA, GAL	M6	Pocket filters made of NanoWave® medium	Pocket filter
F768...	PFN	PLA, GAL	F7	Pocket filters made of NanoWave® medium	Pocket filter
F769...	PFN	PLA, GAL	F9	Pocket filters made of NanoWave® medium	Pocket filter

① Previous name ② New name ③ Construction ④ Filter class ⑤ Product

New product names for filter elements

①	②	③	④	⑤	
F770E...	DFH	STA	E11	Particulate filter cells	Deep Pleat filters
F770M...	DFH	GAL	E11	Particulate filter cells	Deep Pleat filters
F770W...	DFH	MDF	E11	Particulate filter cells	Deep Pleat filters
F771E...	DFH	STA	H13	Particulate filter cells	Deep Pleat filters
F771M...	DFH	GAL	H13	Particulate filter cells	Deep Pleat filters
F771W...	DFH	MDF	H13	Particulate filter cells	Deep Pleat filters
F779S...	MFI	SPC	E10	Filter inserts	Mini Pleat filters
F780A...	MFE	AL	E11	Filter elements	Mini Pleat filters
F780AR...	MFCA	AL	E11	Filter cartridges	Mini Pleat filters
F780E...	MFC	STA	E11	Filter cells	Mini Pleat filters
F780E...	MFP	STA	E11	Filter panels	Mini Pleat filters
F780M...	MFE	GAL	E11	Filter elements	Mini Pleat filters
F780M...	MFC	GAL	E11	Filter cells	Mini Pleat filters
F780M...	MFP	GAL	E11	Filter panels	Mini Pleat filters
F780N...	MFP	ALN	E11	Filter panels	Mini Pleat filters
F780S...	MFI	SPC	E11	Filter inserts	Mini Pleat filters
F780V...	MFP	ALV	E11	Filter panels	Mini Pleat filters
F780W...	MFC	MDF	E11	Filter cells	Mini Pleat filters
F780W...	MFP	MDF	E11	Filter panels	Mini Pleat filters
F780Y...	MFP	ALY	E11	Filter panels	Mini Pleat filters
F780Z...	MFP	ALZ	E11	Filter panels	Mini Pleat filters
F781A...	MFE	AL	H13	Filter elements	Mini Pleat filters
F781AR...	MFCA	AL	H13	Filter cartridges	Mini Pleat filters
F781E...	MFP	STA	H13	Filter panels	Mini Pleat filters
F781E...	MFC	STA	H13	Filter cells	Mini Pleat filters
F781M...	MFE	GAL	H13	Filter elements	Mini Pleat filters
F781M...	MFC	GAL	H13	Filter cells	Mini Pleat filters
F781M...	MFP	GAL	H13	Filter panels	Mini Pleat filters
F781N...	MFP	ALN	H13	Filter panels	Mini Pleat filters
F781S...	MFI	SPC	H13	Filter inserts	Mini Pleat filters
F781U...	MFP	ALU	H13	Filter panels	Mini Pleat filters
F781V...	MFP	ALV	H13	Filter panels	Mini Pleat filters
F781W...	MFC	MDF	H13	Filter cells	Mini Pleat filters
F781W...	MFP	MDF	H13	Filter panels	Mini Pleat filters
F781Y...	MFP	ALY	H13	Filter panels	Mini Pleat filters
F781Z...	MFP	ALZ	H13	Filter panels	Mini Pleat filters
F782B...	MFPCR	ALB	H14	Filter panels for clean room technology	Mini Pleat filters
F782C...	MFPCR	ALC	H14	Filter panels for clean room technology	Mini Pleat filters
F782E...	MFC	STA	H14	Filter cells	Mini Pleat filters
F782E...	MFP	STA	H14	Filter panels	Mini Pleat filters
F782G...	MFPCR	ALG	H14	Filter panels for clean room technology	Mini Pleat filters
F782M...	MFC	GAL	H14	Filter cells	Mini Pleat filters
F782M...	MFP	GAL	H14	Filter panels	Mini Pleat filters
F782S...	MFI	SPC	H14	Filter inserts	Mini Pleat filters
F782U...	MFP	ALU	H14	Filter panels	Mini Pleat filters
F782V...	MFP	ALV	H14	Filter panels	Mini Pleat filters
F782W...	MFC	MDF	H14	Filter cells	Mini Pleat filters
F782W...	MFP	MDF	H14	Filter panels	Mini Pleat filters
F782Y...	MFP	ALY	H14	Filter panels	Mini Pleat filters
F782Z...	MFP	ALZ	H14	Filter panels	Mini Pleat filters

① Previous name ② New name ③ Construction ④ Filter class ⑤ Product

New product names for filter elements

①	②	③	④	⑤
F783B...	MFPCR	ALB	U15	Filter panels for clean room technology Mini Pleat filters
F783C...	MFPCR	ALC	U15	Filter panels for clean room technology Mini Pleat filters
F783G...	MFPCR	ALG	U15	Filter panels for clean room technology Mini Pleat filters
F784C...	MFPCR	ALC	U16	Filter panels for clean room technology Mini Pleat filters
F784G...	MFPCR	ALG	U16	Filter panels for clean room technology Mini Pleat filters
New variant	MFP	ALZ	M6	Filter panels Mini Pleat filters
New variant	MFP	ALZ	F7	Filter panels Mini Pleat filters
New variant	MFP	ALZ	F9	Filter panels Mini Pleat filters
New type	FHD	D, R, V	E11	Filter panels with hood Mini Pleat filters
New type	FHD	D, R, V	H13	Filter panels with hood Mini Pleat filters
New type	FHD	D, R, V	H14	Filter panels with hood Mini Pleat filters
New type	FHD	D, R, V	U15	Filter panels with hood Mini Pleat filters
New variant	ACFI	PLA	PF	Filter inserts Activated carbon filters

① Previous name ② New name ③ Construction ④ Filter class ⑤ Product