

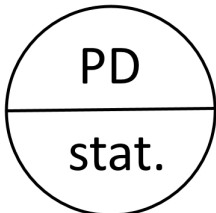

XD0 for TVR, TVJ, TVT,
TZ-SILENZIO, TA-
SILENZIO, TVZ, TVA,
TVRK



Static transducer type

Control component

XD0



Control components for VAV terminal unit with static transducer

Compact device for use with VAV terminal units

- Controller, static differential pressure transducer and actuator in one casing
- Use in ventilation and air conditioning systems, with clean and contaminated air
- Suitable for constant and variable volume flow rates
- Activation of override controls via external switch contacts
- Volume flow rates q_{vmin} and q_{vmax} are parameterised in the factory and saved in the controller
- Change of operating parameters using adjustment devices
- Service access for manual adjustment devices and PC configuration software

General information	2	Variants	6
Function	3	Technical data	7
Specification text	4	Product details	8
Order code	5	Explanation	11

General information

Application

- All-in-one control devices for VAV terminal units
- Static differential pressure transducer, electronic controller, and actuator are fitted together in one casing
- For broader range of applications with clean and contaminated air, e.g. in the outlet area with dust and fluff
- Suitable for different control tasks depending on the specification of the setpoint value
- The room temperature controller, central BMS, air quality controller or similar units control the variable volume flow control by specifying setpoint values via analogue signal
- Override controls for activating q_{vmin} , q_{vmax} , shut-off, OPEN position via switch or relay possible
- Volume flow rate actual value is available as linear voltage signal
- Standard filtration in comfort air conditioning systems allows for use of the controller in the supply air without additional dust protection.

Control concept

- The volume flow controller works independent of the duct pressure
- Differential pressure fluctuations do not result in permanent volume flow rate changes
- To prevent the control from becoming unstable, a dead band is allowed within which the damper blade does not move.
- Volume flow rate range parameterised in the controller in the factory
 q_{vmin} : minimum volume flow rate
 q_{vmax} : maximum volume flow rate
- Operating parameters are specified via the order code and parameterised in the factory

Operating modes

- Variable or constant value
- Variable operation (V)
 Setpoint value setting via analogue interface
 Signal voltage range corresponds to q_{vmin} to q_{vmax}

- Constant value mode (F)
 A setpoint signal is not required, setpoint value corresponds to q_{vmin}

Interface

Analogue interface with adjustable signal voltage range

- Analogue signal for volume flow rate setpoint value
- Analogue signal for volume flow rate actual value (factory setting), alternatively: analogue signal for damper blade position (adjustment by others required)

Signal voltage ranges

- 0 – 10 V DC
- 2 – 10 V DC

Parts and characteristics

- Transducer for static measurement principle
- Overload protection
- Release button to allow for manual operation
- Connecting cable with 4 wires, approx. 0.9 m, halogen-free
- Service interface

Construction

Type 227V-024-15-DS3 for volume flow controller

- TVR, TVJ, TZ-Silenzio, TA-Silenzio, TVZ, TVA, TVRK
- TVT (to 1000 x 500 mm)

Commissioning

- Due to the volume flow rates set in the factory, always ensure that the control units are only installed in the specified locations
- After successful installation and wiring the controller is ready for use
- Operating parameters can be adjusted by the customer (via the adjustment device)

Useful additions

- Adjustment device type GUIV-A (order code AT-VAV-G)

Function

A closed control circuit for regulation of the volume flow rate, i.e. measuring - comparing - adjusting, is characteristic of air terminal units.

The volume flow rate is measured by measuring a differential pressure (effective pressure). This is done via a differential pressure sensor. An integrated differential pressure transducer converts the effective pressure into a voltage signal. The volume flow rate actual value is hence available as a voltage signal. The

factory setting is such that 10 V DC always corresponds to the nominal volume flow rate (q_{vnom}).

The volume flow rate setpoint value is specified by a higher-level controller (e.g. room temperature controller, air quality controller, central BMS). Variable volume flow control results in a value between q_{vmin} and q_{vmax} . It is possible to override the room temperature control, e.g. by a complete shut-off of the duct. The controller compares the volume flow rate setpoint value to the actual value and controls the integral actuator accordingly.

Principle of operation for type 227V-024-15-DS3 (Type TVT, TVJ, TZ-Silenzio, TA-Silenzio, TVZ, TVA, TVRK)

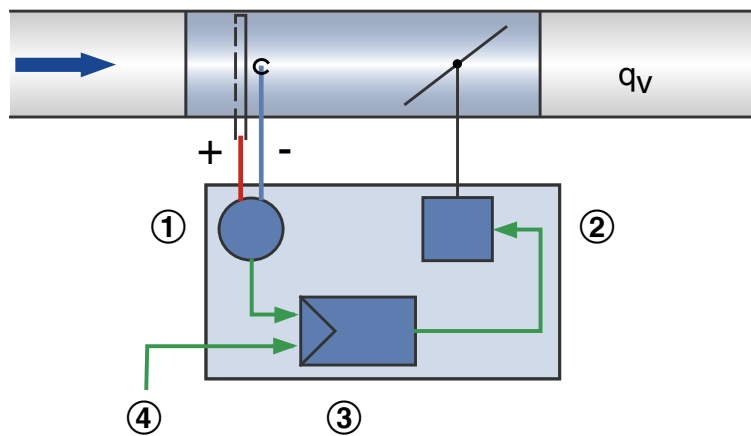

- ① Differential pressure transducer
- ② Actuator

- ③ Volume flow controller
- ④ Setpoint value signal

Specification text

This specification text describes the general properties of the product.

Category

- Compact controller for volume flow control
- Regulation of a constant or variable volume flow rate setpoint
- Electronic controller for applying a reference variable and tapping an actual value
- The actual value relates to the nominal volume flow rate such that commissioning and subsequent adjustment are simplified
- Stand-alone operation or integration in central building management system

Application

- Static transducer for polluted air in ventilation and air conditioning systems

Supply voltage

- 24 V AC / DC

Actuator

- Integrated; Slow running (running time <150s for 90°)

Installation orientation

- either direction

Interface/Control

- Analogue signals (0 – 10V or 2 – 10V DC)

Connection

- Connecting cable with 4 wires

Interface information

Analogue:

- Volume flow rate actual value and setpoint value
- Actual value of volume flow rate, at the factory
- Actual value cannot be configured by others on damper blade position

Special functions

- Activation q_{vmin} , q_{vmax} , closed, open by external switch contacts

Parameter settings

- Parameters specific to VAV terminal unit parameterised at the factory
- Operating values: q_{vmin} , q_{vmax} and Interface type parameterised in the factory
- Subsequent adjustment via optional tools: adjustment device, PC software (wired in each case)

Factory settings

- Electronic controller factory-mounted on the terminal unit
- Factory parameter settings
- Functional test under air; certified with sticker

Order code

TVR – D / 200 / D2 / XD0 / V 0 / qvmin – qvmax m³/h
 | | | | | | | | | |
 1 2 5 6 7 8 9 10 11

1 Type

TVR VAV terminal unit

2 Acoustic cladding

No entry: none

D With acoustic cladding

3 Material

Galvanised sheet steel (Standard construction)

P1 Powder-coated RAL 7001, silver grey

A2 Stainless steel construction

5 Nominal size [mm]

100, 125, 160, 200, 250

6 Accessories

No entry: none

D2 Double lip seal both sides

G2 Matching flanges for both ends

7 Attachments (control component)

XD0 Compact controller static transducer

8 Operating mode

F Constant value (a setpoint value)

V Variable (setpoint value range)

9 Signal voltage range

0 0 – 10 V DC

2 2 – 10 V DC

10 Operating values for factory setting

Volume flow rates [m³/h or l/s]

q_{vconst} (only with operating mode F)

q_{vmin} (only with operating mode V)

q_{vmax} (only with operating mode V)

11 Volume flow unit

m³/h

l/s

Order example: TVR/100/D2/XD0/V0/50-354 m³/h

Acoustic cladding

Without

Material

Galvanised sheet steel

Nominal size

100 mm

Accessories

Double lip seal both sides

Attachment

Compact controller, static transducer

Operating mode

Variable operation – signal voltage range 0 – 10 V DC

Volume flow rate

50 – 354 m³/h

Order example: TVJ-D/600x300/XD0/F2/6000 m³/h

Acoustic cladding

With

Material

Galvanised sheet steel

Dimensions

600 x 300

Accessories

None

Attachment

Compact controller, static transducer

Operating mode

Constant value mode, signal voltage range 2 – 10V DC

Volume flow rate

6000 m³/h

Variants

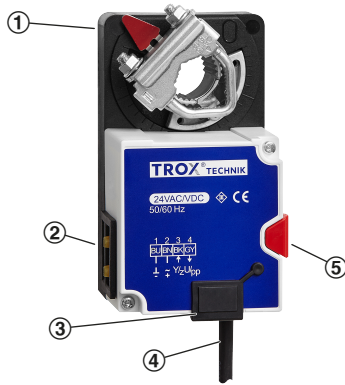

- ① Compact controller
- ② Tube connections for differential pressure transducer
- ③ Connection service tool
- ④ Connecting cable
- ⑤ Gear release button

Reverse with rating plate

Technical data

Compact controllers for VAV terminal units

VAV terminal units	Type of installation component	Part number
TVR, TVJ, TVT, TZ-Silenzio, TA-Silenzio, TVZ, TVA, TVRK	227V-024-15-DS3	A00000038351

Actuator 227V-024-15-DS3



Compact controller 227V-024-15-DS3

Supply voltage (AC)	24 V AC $\pm 20\%$, 50/60 Hz
Supply voltage (DC)	24 V DC $\pm 20\%$
Power rating (AC)	3.5 VA max.
Power rating (DC)	Max. 2 W
Torque	15 Nm
Setpoint value signal input	0 – 10 V DC, $R_a > 100 \text{ k}\Omega$ or 2 – 10 V DC, $R_a > 50 \text{ k}\Omega$
Actual value signal output	0 – 10 V DC or 2 – 10 V DC, max. 0,5 mA
IEC protection class	III (protective extra-low voltage)
Protection level	IP 42
EC conformity	EMC to 2014/30/EU

Product details

Analogue interface 0 – 10 V or 2 – 10 V DC (operating mode V, F)

The analogue interface can be adjusted for the signal voltage range 0 – 10 V DC or 2 – 10 V DC. The assignment of the volume flow rate setpoint value or actual value for voltage signals is shown in the characteristic curves.

- The set signal voltage range is always equally valid for setpoint value and actual value signals.
- The signal voltage range is pre-set in the factory in accordance with the order code entries.
- The signal voltage range can be adjusted by others with an adjustment device.

Setpoint value setting

- In the operating mode V (variable operation), the setpoint value is specified with an analogue signal on terminal Y.
- The selected signal voltage range 0 – 10 V or 2 – 10 V DC is assigned to the volume flow rate range $q_{vmin} - q_{vmax}$ a change packet.
- Volume flow rate range $q_{vmin} - q_{vmax}$ is pre-set in the factory according to the order code entries.
- Subsequent adjustment of q_{vmin} or q_{vmax} possible with adjustment device.
- In the operating mode F (constant value mode), an analogue signal is not required on terminal Y.
- It is controlled by the volume flow rate constant value set by q_{vmin} set volume flow rate constant value regulated.
- Volume flow rate q_{vmin} is pre-set in the factory according to the order code entry.
- Subsequent adjustment of q_{vmin} possible with adjustment device.

Actual value as feedback for monitoring or tracking control

- On terminal U, the actual volume flow rate measured by the controller can be tapped as a voltage signal.
- The selected signal voltage range 0 – 10 V DC or 2 – 10 V DC is shown in the volume flow rate range 0 – q_{vnom} shown.

Override control

For special operating situations, the volume flow controller can be put in a special operating mode (override control). The following are possible: control q_{vmin} , control q_{vmax} , damper blade in the OPEN position or damper blade CLOSED.

Override control via signal input Y

With appropriate wiring on the signal input Y, the override controls can be activated according to the connection diagrams via wiring with external switch contacts/relays. OPEN and CLOSED are only available if the controller is supplied with alternating current (AC).

Override control CLOSED via control signal Y

- With signal voltage range 0 – 10 V DC: CLOSED is activated when $q_{vmin} = 0$ is set and the control signal is $Y < 0.5V$ DC.
- With signal voltage range 2 – 10 V DC: CLOSED is activated when control signal is $Y < 0.8V_{(r1)}$ DC.
(r1) 0.8V = factory setting

Override control for diagnostic purposes

- For test purposes, the override control can also be activated via the service tools (adjustment device, PC software).

Prioritisation of various setting options

- High priority: settings via the service connector (adjustment device, PC software) for test purposes
- Low priority: settings via wiring on the Y signal input of the controller

XD0, Characteristic of the setpoint value signal

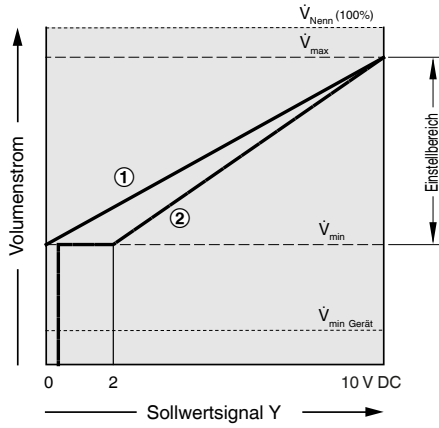

- ① Signal voltage range 0 – 10 V DC
- ② Signal voltage range 2 – 10 V DC

XD0, Characteristic of the actual value signal

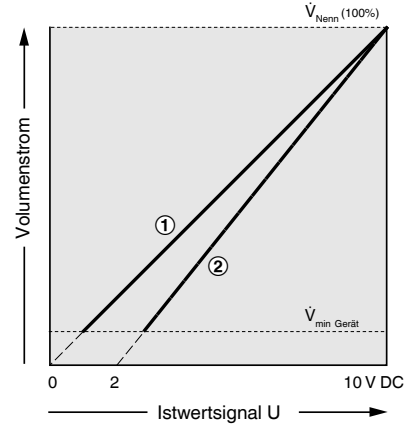

- ① Signal voltage range 0 – 10 V DC
- ② Signal voltage range 2 – 10 V DC

Calculation volume flow rate setpoint value at 0 – 10 V:

0 – 10 V DC

$$\dot{V}_{\text{Soll}} = \frac{Y}{10} (\dot{V}_{\text{max}} - \dot{V}_{\text{min}}) + \dot{V}_{\text{min}}$$

Calculation volume flow rate actual value at 0 – 10 V:

0 – 10 V DC

$$\dot{V}_{\text{Ist}} = \frac{U}{10} \dot{V}_{\text{Nenn}}$$

Calculation volume flow rate setpoint value at 2 – 10 V:

2 – 10 V DC

$$\dot{V}_{\text{Soll}} = \frac{Y-2}{8} (\dot{V}_{\text{max}} - \dot{V}_{\text{min}}) + \dot{V}_{\text{min}}$$

Calculation volume flow rate actual value at 2 – 10 V:

2 – 10 V DC

$$\dot{V}_{\text{Ist}} = \frac{U-2}{8} \dot{V}_{\text{Nenn}}$$

Commissioning

- On-site adjusting is not required
- Due to the volume flow rates set in the factory, always ensure that the control units are only installed in the specified locations
- After successful installation and wiring the controller is ready for use
- Comply with the volume flow rate control ranges of the VAV terminal units, do not set a volume flow rate which is below the minimum flow rate

Connecting cable core identification at 227V-024-15-DS3 (for TVR, TVJ, TVT, TZ-Silenzio, TA-Silenzio, TVZ, TVA, TVM)

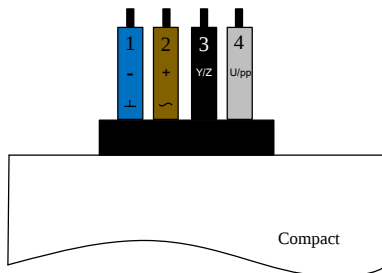

- 1: BU, ⊥, -: Ground, neutral
- 2: BN, ~, +: Supply voltage 24 V
- 3: BK, Y/Z: Setpoint value signal Y and override control
- 4: GY, U/pp: Actual value signal for service tool

Variable volume flow control and override control

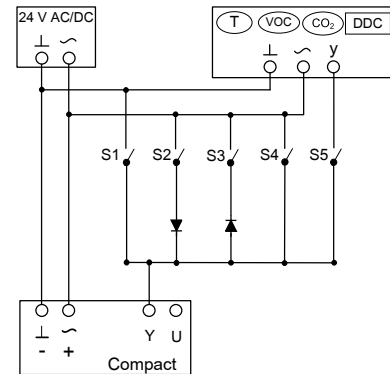

Switch functions:

- S1 Damper blade closed CLOSED when $V_{min} = 0$
- S2 Damper blade open OPEN (only with supply voltage 24 V AC)
- S3 Damper blade closed CLOSED (only with supply voltage 24 V AC)
- S4 Maximum volume flow rate q_{vmax}
- S5 Room temperature control

All switches open: Minimum volume flow rate q_{vmin}

T, VOC, CO2, DDC = Setpoint value setting

When combining several override controls the switches must be interlocked to prevent short-circuits.

Diode: e.g. 1N 4007

Explanation

q_{vNenn} [m³/h]; [l/s]

Nominal volume flow rate (100 %): The value depends on product type and nominal size. Values are published on the internet and in technical leaflets, and stored in the Easy Product Finder design software. Reference value for calculating percentages (e.g. q_{vmax}). Upper limit of the setting range and maximum volume flow rate setpoint value for the VAV terminal unit.

$q_{vmin\ Gerät}$ [m³/h]; [l/s]

Technically possible minimum volume flow rate: The value depends on product type, nominal size and control component (attachment). Values are stored in the Easy Product Finder design software. Lower limit of the setting range and minimum volume flow rate setpoint value for the VAV terminal unit. Depending on the controller, setpoint values below q_{vmin} unit (if q_{vmin} equals zero) may result in unstable control or shut-off.

q_{vmax} [m³/h]; [l/s]

Upper limit of the operating range for the VAV terminal unit that can be set by customers: q_{vmax} can only be smaller than or equal to q_{vnom} . In case of analogue signalling to volume flow controllers (which are typically used), the set maximum value (q_{vmax}) is allocated to the setpoint signal maximum (10 V) (see characteristic).

q_{vmin} [m³/h]; [l/s]

Lower limit of the operating range for the VAV terminal unit that can be set by customers: q_{vmin} should be smaller than or equal to q_{vmax} . Do not set q_{vmin} smaller than q_{vmin} unit, otherwise the control may become unstable or the damper blade may close. q_{vmin} may equal zero. In case of analogue signalling to volume flow controllers (which are typically used), the set minimum value (q_{vmin}) is allocated to the setpoint signal minimum (0 or 2 V) (see characteristic).

q_v [m³/h]; [l/s]

Volume flow rate

Δ_{pst} [Pa]

Static differential pressure

$\Delta_{pst\ min}$ [Pa]

Static differential pressure, minimum: The static minimum differential pressure is equal to the pressure loss of the VAV controller when the damper blade is open, caused by flow resistance (damper blade). If the pressure on the VAV controller is too low, the setpoint volume flow rate may not be achieved, not even when the damper blade is open. Important factor in designing the ductwork and in rating the fan including speed control. Sufficient differential pressure must be ensured for all operating conditions and for all controllers, and the measurement point or points for speed control must have been selected accordingly to achieve this.