

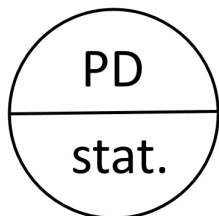

XB0 for other series



Static transducer type

# Control component

## XF0



### Control component for VAV terminal unit for duct pressure control

Compact device for use with VAV terminal units

- Controller, static differential pressure transducer and actuator are fitted together in one casing
- Duct pressure control in ventilation and air conditioning systems up to 550 Pa, e.g. line pressure control
- Suitable for clean and polluted air
- Constant value control  $P_{\min}$  or variable control  $P_{\min} - P_{\max}$
- Operating parameters  $P_{\min}$  and  $P_{\max}$  are parameterised in the factory and saved in the controller
- Activation of override controls via external switch contacts
- Change of operating parameters using adjustment devices
- Service access for manual adjustment devices and PC configuration software

General information	2	Variants	6
Function	3	Technical data	7
Specification text	4	Product details	8
Order code	5	Explanation	11

## General information

### Application

- All-in-one control devices for duct pressure control
- Static differential pressure transducer, electronic controller, and actuator are fitted together in one casing
- Integration in central building management system or stand-alone operation
- Variable duct pressure control through setting setpoint values via analogue signal generated by the central building management system
- Constant value control for constant duct pressure without additional signalling thanks to parameterised operating value
- Override controls for the activation of shut-off, OPEN position, control stop possible via switch contacts or relay
- Pressure actual value is available as linear voltage signal

### Control concept

- Duct pressure fluctuations are compensated
- To prevent the control from becoming unstable, a dead band is allowed within which the damper blade does not move
- $P_{\min}$ : selected operating value of lowest duct pressure or constant value
- $P_{\max}$ : selected operating value of highest duct pressure
- Operating parameters are specified via the order code and parameterised in the factory

### Operating modes

- Variable or constant value

#### Variable operation (V)

- Setpoint value setting via analogue interface
- Signal voltage range corresponds to  $P_{\min}$  to  $P_{\max}$

#### Constant value mode (F)

- A setpoint value signal is not required
- Setpoint value corresponds to  $P_{\min}$

### Interface

#### Analogue interface with adjustable signal voltage range

- Analogue signal for pressure setpoint value
- Analogue signal for pressure actual value

### Signal voltage ranges

- 0 – 10 V DC
- 2 – 10 V DC

### Operating parameters

- Observe the variable duct pressure range from 25 – 550 Pa
- Reference point for the output signal: nominal pressure 600 Pa

### Parts and characteristics

- Transducer for static measurement principle
- Overload protection
- Release button to allow for manual operation
- Terminals with cover
- Service interface

#### Note:

Depending on variant, e.g. acoustic cladding, differential pressure sensors or pressure connections of the control unit are not accessible for this attachment.

### Construction

Type 227P-024-15-DS6 for control units of series

- TVR, TVJ, TZ-Silenzio, TA-Silenzio, TVZ, TVA, TVRK
- TVT up to 1000 x 500

### Commissioning

- Due to the duct pressures set in the factory, always ensure that the control units are only installed in the specified locations
- Install the control unit and wire the control component
- Install the duct pressure tap and connect to the control component via tubing
- The controller is then ready for use
- Operating parameters can be adjusted by the customer via the adjustment device

### Useful additions

- Adjustment device type GUIV-A (order code AT-VAV-G) for type 227P-024-15-DS6

## Function

A static differential pressure transducer converts the differential pressure into a voltage signal. The differential pressure actual value is available as a voltage signal. The factory setting is such that 10 V DC always corresponds to the nominal differential pressure ( $\Delta p_{nom}$ ). The differential pressure setpoint value is either

a constant value or it comes from a setpoint adjuster or from switch contacts. The controller compares the differential pressure setpoint value to the actual value and controls the actuator accordingly. Differential pressure parameters and signal voltage range are stored in the control component. Changes on the customer's site can easily be carried out using an adjustment device or a notebook with service tool.

### Principle of operation for type 227P-024-15-DS6

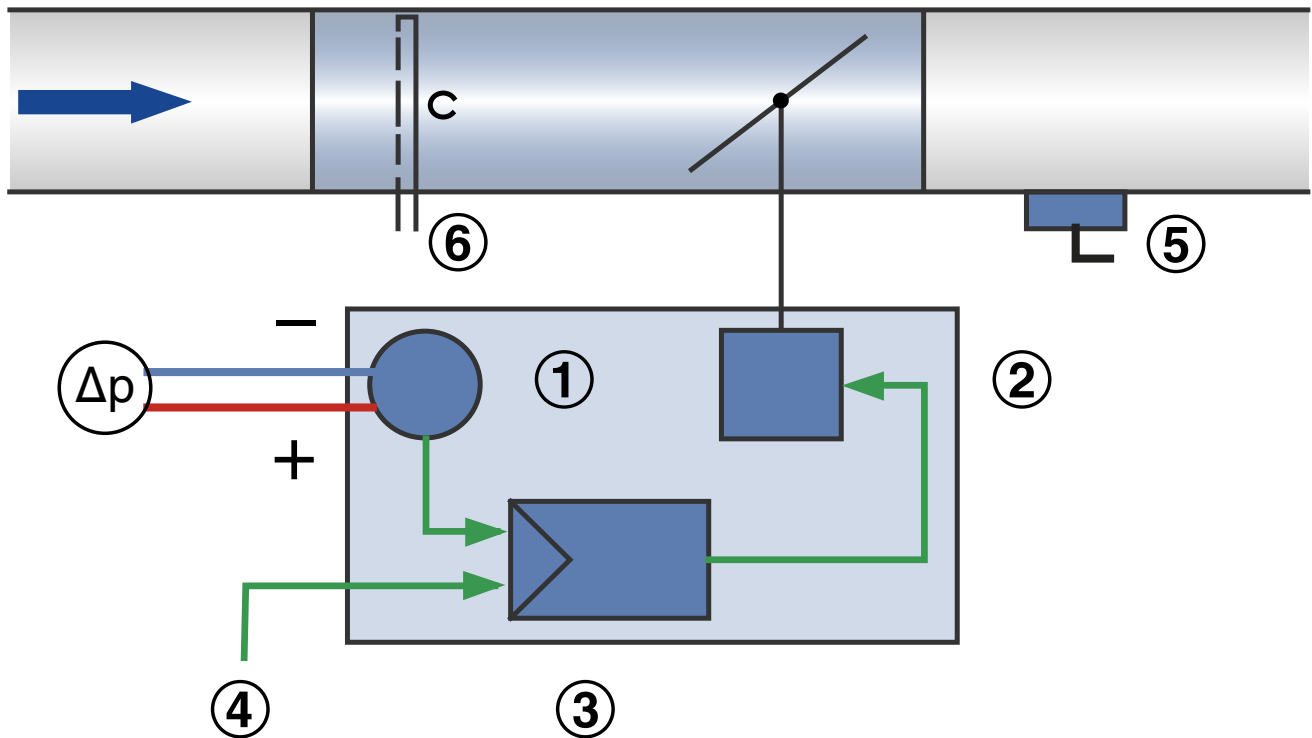

- ① Differential pressure transducer
- ② Actuator
- ③ Differential pressure controller
- ④ Setpoint value signal or programmed fixed constant value
- ⑤ Duct pressure tapping point
- ⑥ Differential pressure sensor of the VAV terminal unit (unused, depending on types and variant possibly not accessible or not

- available)
- ( $\Delta p$ ) Differential pressure connection at the transducer of the control component, depending on the installation situation (supply air/exhaust air):
  - One connection side for duct pressure measurement - see ⑤
  - Other connection side open as reference value

## Specification text

This specification text describes the general properties of the product.

### Category

- Compact controller for duct pressure
- Control of a constant or variable duct pressure setpoint
- Electronic controller for connecting a controlled variable and tapping an actual value signal
- The actual value signal relates to the nominal pressure such that commissioning and subsequent adjustment are simplified
- Stand-alone operation or integration in central building management system

### Application

- Static transducer for duct pressure control in ventilation and air conditioning systems
- Control range 25 – 550 Pa

### Supply voltage

- 24 V AC / DC

### Actuator

- Integrated; slow running (running time 150 s for 90°)

### Installation orientation

- either direction

### Interface/Control

- Analogue signals (0 – 10V or 2 – 10V DC)

### Connection

- Connecting cable with 4 wires

### Interface information

- Analogue
- Duct pressure setpoint and actual value

### Special functions

- Activation  $P_{min}$ ,  $P_{max}$ , Closed, Open, Control Stop by means of external switch contacts/circuitry

### Parameter settings

- Operating parameters  $P_{min}$ ,  $P_{max}$  Factory parameterised
- Signal characteristic factory parameterised
- Subsequent adjustment using optional tools: adjustment device, PC software (wired in each case)

### Factory settings

- Electronic controller factory-mounted on the terminal unit
- Factory parameterisation; certified with sticker



## Order code

**TVR – D / 200 / D2 / XF0 / V 0 / Pmin – Pmax Pa**  
 |     |     |     |     |     |     |     |     |  
**1     2     5     6     7     9 10     11     12**

**1 Type**

**TVR** VAV terminal unit

**XF0** Compact controller of dynamic transducer

**2 Acoustic cladding**

No entry: none

**D** With acoustic cladding

**8 Equipment function/Installation location**

**PDS** Duct pressure control, supply air

**PDE** Duct pressure control, extract air

**3 Material**

Galvanised sheet steel (Standard construction)

**P1** Powder-coated RAL 7001, silver grey

**A2** Stainless steel construction

**9 Operating mode**

**F** Constant value (a setpoint value)

**V** Variable (setpoint value range)

**5 Nominal size [mm]**

**100, 125, 160, 200, 250**

**10 Signal voltage range**

**0** 0 – 10 V DC

**2** 2 – 10 V DC

**6 Accessories**

No entry: none

**D2** Double lip seal both sides

**G2** Matching flanges for both ends

**11 Operating values for factory setting**

Duct pressure in Pa

$P_{const}$  (only with operating mode F)

$P_{vmin}$  (only with operating mode V)

$P_{vmax}$  (only with operating mode V)

**7 Attachments (control component)**

**Order example: TVR/100/D2/XF0/PDS/V0/300-500 Pa**

Acoustic cladding	None
Material	Galvanised sheet steel
Nominal size	100 mm
Accessories	Double lip seal both sides
Attachment	Compact controller for duct pressure
Equipment function/Installation location	Duct pressure control, supply air
Operating mode	Variable operation – signal voltage range 0 – 10 V DC
Operating value	300 – 500 Pa

**Order example: TVJ-D/600x300/XF0/PDE/F2/450 Pa**

Acoustic cladding	With
Material	Galvanised sheet steel
Dimensions	600 x 300
Accessories	None
Attachment	Compact controller for duct pressure
Equipment function/Installation location	Duct pressure control, extract air
Operating mode	Constant value mode, signal voltage range 2 – 10 V DC
Operating value	450 Pa

# Variants

## 227P-024-15-DS6

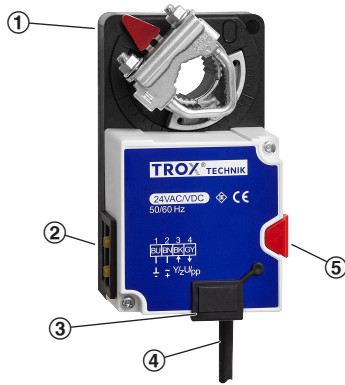

- ① Compact controller
- ④ Tube connections for differential pressure transducer
- ③ Connection service tool
- ④ Connecting cable
- ⑤ Gear release button

Reverse with rating plate

## Technical data

### Compact controllers for VAV terminal units

VAV terminal units	Type of installation component	Part number
TVR, TVJ, TVT, TZ-Silenzio, TA-Silenzio, TVZ, TVA, TVRK	227P-024-15-DS6	A00000038356

### Actuator 227P-024-15-DS6



### 227P-024-15-DS6

Supply voltage (AC)	24 V AC $\pm 20\%$ , 50/60 Hz
Supply voltage (DC)	24 V DC $\pm 20\%$
Power rating (AC)	5 VA max.
Power rating (DC)	Max. 2.5 W
nominal pressure range	0 – 600 Pa
pressure control range	25 – 550 Pa
Torque	15 Nm
Setpoint value signal input	0 – 10 V DC, $R_a > 100 \text{ k}\Omega$ or 2 – 10 V DC, $R_a > 50 \text{ k}\Omega$
Actual value signal output	0 – 10 V DC or 2 – 10 V DC, 0.5 mA max.
IEC protection class	III (protective extra-low voltage)
Protection level	IP 42
EC conformity	EMC to 2014/30/EU

## Product details

### Analogue interface 0 – 10V or 2 – 10V DC (operating mode V, F)

The analogue interface can be adjusted for the signal voltage range 0 – 10V DC or 2 – 10V DC. The assignment of the duct pressure setpoint value or actual value for voltage signals is shown in the characteristic curves.

- The set signal voltage range is always equally valid for setpoint value and actual value signals.
- The signal voltage range is pre-set in the factory in accordance with the order code entries.
- The signal voltage range can be adjusted by others with an adjustment device.

### Setpoint value setting

Variable operation

- In the operating mode V (variable operation), the setpoint value is specified with an analogue signal on terminal Y.
- The selected signal voltage range 0 – 10V or 2 – 10V DC is assigned to the pressure range  $P_{\min}$  –  $P_{\max}$  set.
- Operating values  $P_{\min}$  –  $P_{\max}$  pre-set in the factory according to the order code entries.
- Subsequent adjustment of  $P_{\min}$  or  $P_{\max}$  possible with adjustment device.

Constant value mode

- In the operating mode F (constant value mode), an analogue signal is not required on terminal Y.
- The volume flow rate constant value set by  $P_{\min}$  is regulated.
- Operating value  $P_{\min}$  is pre-set in the factory according to the order code entry.
- Subsequent adjustment of  $P_{\min}$  possible with adjustment device.

### Actual value as feedback for monitoring or tracking control

- The actual duct pressure rate measured by the controller can be tapped as a voltage signal at terminal U.
- The selected signal voltage range 0 – 10V DC or 2 – 10V DC is shown in the pressure range 0 –  $P_{\text{nom}}$ .
- Reference point  $P_{\text{nom}} = 600$  Pa

### Override control

For special operating situations, the duct pressure controller can be put in a special operating mode (override control).

The following are possible: control  $P_{\min}$ , control  $P_{\max}$ , damper blade in the OPEN position, damper blade CLOSED.

Under certain conditions the control can also be suspended (control stop).

### Override control via signal input Y

With appropriate wiring on the signal input Y, the override controls can be activated according to the connection diagrams via wiring with external switch contacts/relays.

OPEN and CLOSED are only available if the controller is supplied with alternating current (AC).

In the signal voltage range 2 – 10 V, the differential pressure control can be suspended (stop) by connecting input Y to GND.

### Override control CLOSED via control signal Y

- With signal voltage range 0 – 10 V DC: CLOSED is activated when  $P_{\min} = 0$  is set and the control signal is  $Y < 0.5V$  DC.
- With signal voltage range 2 – 10V DC: CLOSED is activated when control signal is  $Y < 0.8V^{(*)}$  DC.  
(\*) 0.8V = factory setting

### Override control for diagnostic purposes

- For test purposes, the override control can also be activated via the service tools (adjustment device, PC software).

### Prioritisation of various setting options

- High priority: settings via the service connector (adjustment device, PC software) for test purposes
- Low priority: settings via wiring on the Y signal input of the controller

**Characteristic of the setpoint value signal**

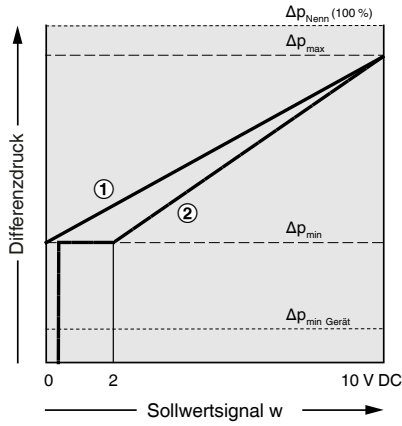

- ① 0 – 10 V DC
- ② 2 – 10 V DC

**Characteristic of the actual value signal**

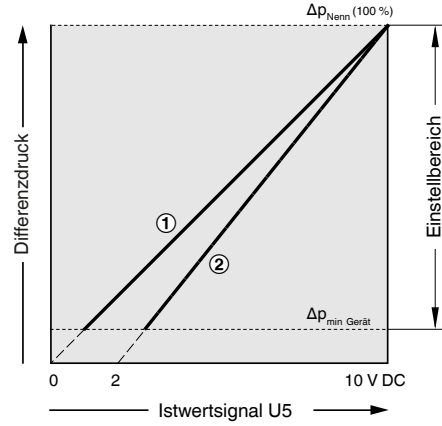

- ① 0 – 10 V DC
- ② 2 – 10 V DC

**Differential pressure setpoint value**

0 – 10 V DC

$$\Delta p_{\text{Soll}} = \frac{w}{10} (\Delta p_{\text{max}} - \Delta p_{\text{min}}) + \Delta p_{\text{min}}$$

**Differential pressure actual value**

0 – 10 V DC

$$\Delta p_{\text{Ist}} = \frac{U5}{10} \Delta p_{\text{Nenn}}$$

**Differential pressure setpoint value**

2 – 10 V DC

$$\Delta p_{\text{Soll}} = \frac{w - 2}{8} (\Delta p_{\text{max}} - \Delta p_{\text{min}}) + \Delta p_{\text{min}}$$

**Differential pressure actual value**

2 – 10 V DC

$$\Delta p_{\text{Ist}} = \frac{U5 - 2}{8} \Delta p_{\text{Nenn}}$$

### Commissioning

- On-site adjusting is not required
  - Due to the duct pressures set in the factory, always ensure that the control units are only installed in the specified locations
  - Install control unit in the duct range to be controlled
  - Set up pressure tap for duct pressure
    - For supply air:
      - Connect the controller connection to the duct to be regulated
      - Leave controller connection open
    - For extract air:
      - Leave controller connection open
      - Connect the controller connection to the duct to be regulated
- The duct must always be connection on the side remote from the fan.
- Note duct pressure control ranges as per technical data
  - Establish electrical wiring connection
  - The controller is then ready for use

### Connecting cable core identification at 227V-024-15-DS3 (for TVR, TVJ, TVT, TZ-Silenzio, TA-Silenzio, TVZ, TVA, TVM)

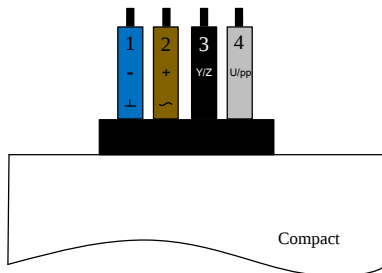

- 1: BU, ⊥, -: Ground, neutral
- 2: BN, ~, +: Supply voltage 24 V
- 3: BK, Y/Z: Setpoint value signal Y and override control
- 4: GY, U/pp: Actual value signal for service tool

### Variable duct pressure control and override control

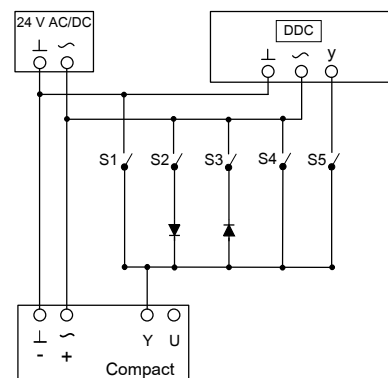

Switch functions:

- S1: Control stop at (only with signal voltage range 2 - 10 V)
- S2: Damper blade OPEN (only with supply voltage 24 V AC)
- S3: Damper blade CLOSED (only with supply voltage 24 V AC)
- S4: Activate setpoint value setting P<sub>max</sub>
- S5: Setpoint value setting - variable duct pressure via control signal

All switches open (input open): Constant value mode with Setpoint value setting P<sub>min</sub>

#### T, VOC, CO<sub>2</sub>, DDC = Setpoint value setting

When combining several override controls the switches must be interlocked to prevent short-circuits.

Diode: e.g. 1N 4007

## Explanation

[Pa]

Nominal pressure (100 %): Maximum differential pressure that can be detected by the pressure transducer and converted into an electrical signal. Please note that the adjustable differential pressure range is only a range of the nominal pressure and cannot be fully utilised (see technical data). P<sub>nom</sub> is the reference value for defining P<sub>min</sub> and P<sub>max</sub>.

P<sub>max</sub> [Pa]

Upper limit of the operating range of the duct pressure regulator adjustable by the customer: P<sub>max</sub> can only be set up to approx. 90 % of P<sub>nom</sub> (see technical data for the usable control range). With analogue control of duct pressure controllers (typically used), the maximum value of the setpoint signal (10 V) is

assigned the set maximum value (P<sub>max</sub>) (see characteristic curve).

P<sub>min</sub> [Pa]

Kundenseitig einstellbare, untere Grenze des Arbeitsbereichs des Kanaldruckreglers: P<sub>min</sub> sollte nur kleiner oder gleich P<sub>max</sub> eingestellt werden. P<sub>min</sub> nicht kleiner als den unteren Regelbereich einstellen, Regelung sonst instabil. Bei analoger Ansteuerung wird dem minimalem Wert des Sollwertsignals (0 oder 2 V) der eingestellte minimale Wert P<sub>min</sub> zugeordnet (siehe Kennlinie).

[Pa]

Differential pressure